

DESCRIPTION

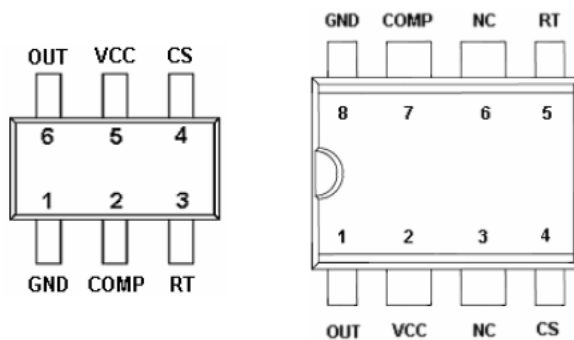
The ST8835 is low cost, startup current, current mode PWM controller with green-mode power-saving operation. The integrated functions include the leading-edge blanking of the current sensing, internal slope compensation. It would provide the users a superior AC/DC power application of higher efficiency, low external computation of higher efficiency, low external component counts, and lower cost solution for applications.

The ST8835 features more protections or functions for the following characteristics :

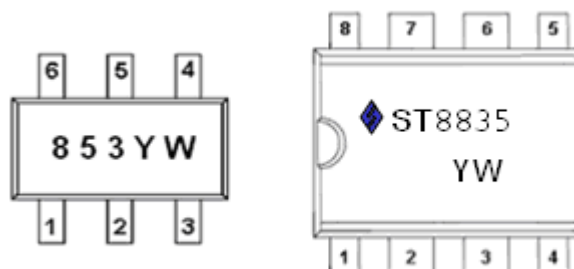
☆Add OLP (Over Load Protection) function to provide better protection performance for fault conditions the OVP (Over Voltage Protection) mechanism form the cycle-by-cycle mode to the hiccup mode. ST6853 is available by SOT-23-6L / DIP-8P packages.

PIN CONFIGURATION

SOT-23-6L / DIP-8P


PART MARKING

SOT-23-6L / DIP-8P



Y: Year Code W: Process Code

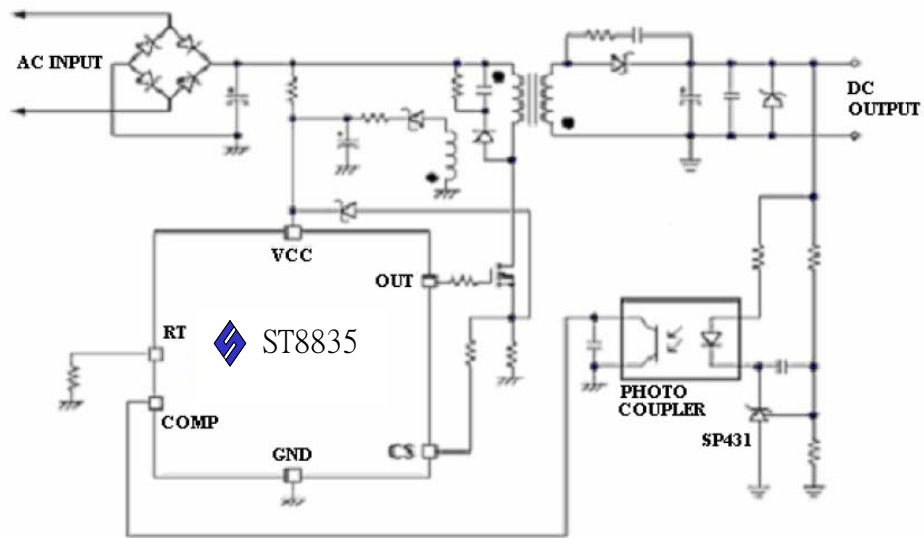
APPLICATUONS

- * AC/DC Switching Power Adaptor
- * Battery Charger
- * PC 5V Standby Power
- * Open-Farme Switching Power Supply

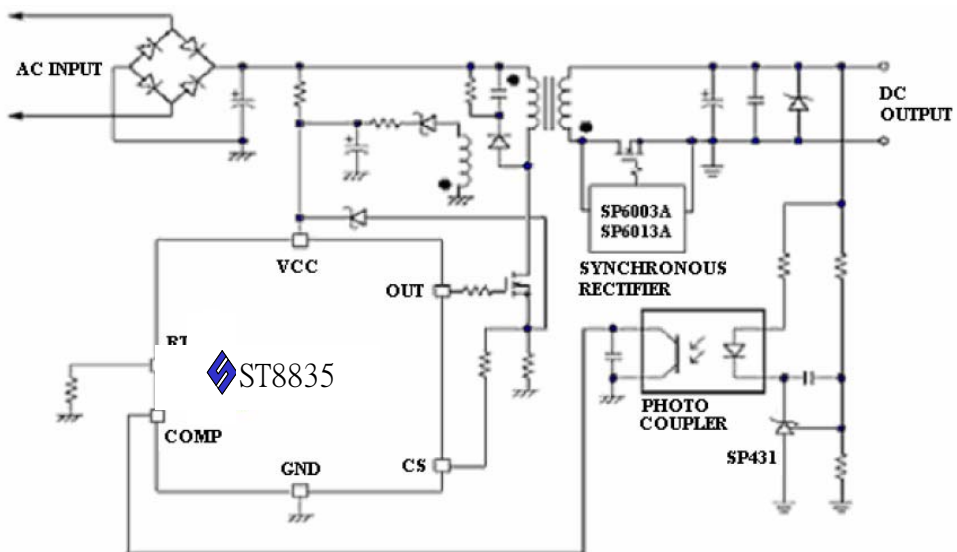
FATURES

- * High-Voltage BiCNOS Process
- * Very Low Startup Current (<20uA)
- * Under Voltage Lockout (UVLO)
- * Current Mode Control
- * Non-audible-noise Green Mode Control Current Limiting
- * LEB (Leading-Edge Blanking) on CS Pin
- * OLP (Over Load Protection)
- * OVP (Over Voltage Protection) on Vcc Pin
- * Leading-Edge Blanking
- * Programmable Switching Frequency
- * Internal Slope Compensation
- * Green-Mode Control for Power Saving
- * 300mA Driving Capability

TYPICAL APPLCATION CIRCURIT



TYPICAL APPLCATUON CIRCURIT (High Efficiency SMPA+Synchronous Rectifier)



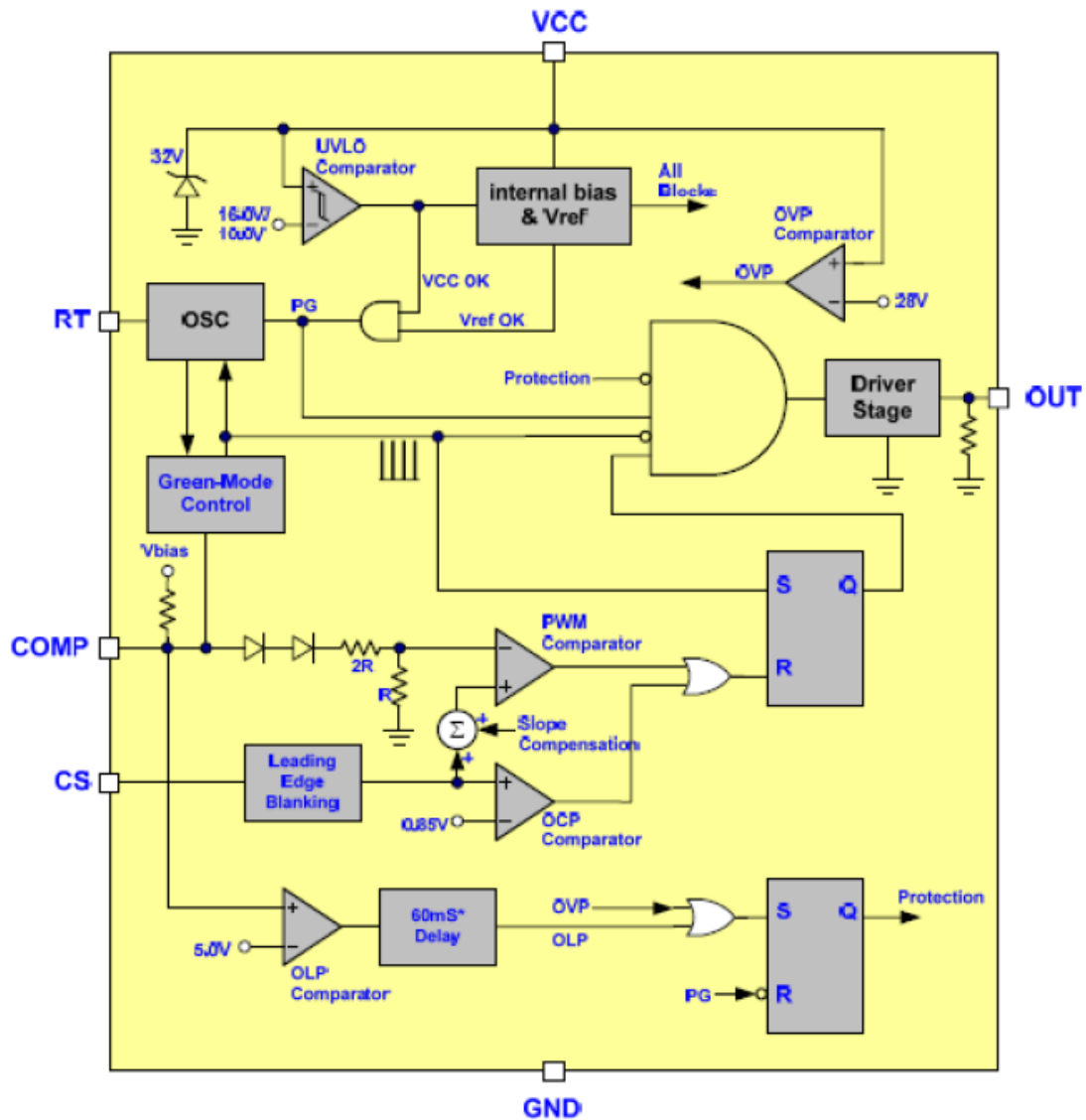


ST8835T8DG

Pin	Symbol	Description
1	OUT	Gate driver output to drive the external MOSFET
2	VCC	Supply Voltage in
3	NC	Unconnected pin
4	CS	Current sense. This pin senses the voltage across a resistor, to control PWM output. This pin also provides current amplitude information for current-mode control.
5	RT	This current is used to charge an internal capacitor, to determine the switching frequency.
6	NC	Unconnected pin
7	COMP	Voltage feedback. The pin provides the output voltage regulation signal., it provides feedback to the internal PWM comparator, so that the PWM comparator can control the duty cycle.
8	GND	Ground

ST8835S26RG

Pin	Symbol	Description
1	GND	Ground
2	COMP	Voltage feedback. The pin provides the output voltage regulation signal., it provides feedback to the internal PWM comparator, so that the PWM comparator can control the duty cycle
3	RT	This current is used to charge an internal capacitor, to determine the switching frequency.
4	CS	Current sense. This pin senses the voltage across a resistor, to control PWM output. This pin also provides current amplitude information for current-mode control
5	VCC	Supply Voltage in
6	OUT	Gate driver output to drive the external MOSFET

BLOCK DIAGRAM




ABSOLUTE MAXIMUM RATINGS (TA=25°C unless otherwise specified)

The following ratings designate persistent limits beyond which damage to the device may occur.

Symbol	Parameter	Value	Unit
V _{CC}	DC Supply Voltage	36	V
V _{COMP/RT/CS}	COMP / RT / CS Voltage	-0.3 ~ 7.0	V
P _D	Power Dissipation @ T _A =85°C (*)	0.3	W
ESD	Human Body Model	4	KV
	Machine Model	300	V
T _{ope}	Operating Ambient Temperature	-40 ~ 85	°C
T _J	Operating Junction Temperature Range	-40 ~ 150	°C
T _{STG}	Storage Temperature Range	-40 ~ 150	°C
T _{LEAD}	Pb-Free Lead Soldering Temperature for 5 sec.	260	°C
R _{θJC}	Thermal Resistance Junction – Case (*)	SOT-23-6L	210
		DIP-8P	95

(*) The power dissipation and thermal resistance are evaluated under copper board mounted with free air conditions.

ELECTRICAL CHARACTERISTICS (TA=25°C Vcc=15V, unless otherwise specified)

Symbol	Parameter	Conditions	Min.	Typ.	Max.	Unit
Supply Voltage (Vcc Pin)						
Istt	Startup Current			10	20	uA
Iop	Operating Current	V _{COMP} = 0V		2.7	4	mA
		V _{COMP} = 3V		2.4		mA
		Protection tripped (OLP, OVP)		1.0		mA
UVLO (off)	Min. Operating Voltage		9.0	10.0	11.0	V
UVLO (on)	Start Threshold Voltage		15.0	16.0	17.0	V
OVP Level	Over Voltage Protection		24	26	29.5	V
Voltage Feedback (Comp Pin)						
Isc	Short Circuit Current			1.25	2.2	mA
Vop	Open Loop Voltage			6		V
V _{TH(GM)}	Green Mode Threshold V _{COMP}			2.35		V
Oscillator (RT Pin)						
Fosc	Frequency	R _T =100KΩ	60.0	68.0	75.0	KHz
Fosc(GM)	Green Mode Frequency	F _s =65.0KHz		22		KHz
Fdt	Frequency Variation versus Temp. Deviation	(-40°C ~105°C)			3	%
Fdv	Frequency Variation versus Vcc Deviation	(Vcc=11V-25V)			1	%
Current Sensing (CS Pin)						
Vcs(off)	Maximum Input Voltage		0.8	0.85	0.9	V
TLEDD	Leading Edge Blanking Time			280		nS
Zcs	Input impedance		1			MΩ
Tpd	Delay to Output			100		nS
Gate Driver Output (OUT Pin)						
DC (Max)	Maximum Duty Cycle		70	75	80	%
DC (Min)	Minimum Duty Cycle			0		%
V _{OL}	Output Low Level	Vcc=15V, I _o =20mA			1	V
V _{OH}	Output High Level	Vcc=15V, I _o =20mA	8			V
Tr	Rising Time	Load Cap=1000pF		50	200	nS
Tf	Falling Time	Load Cap=1000pF		30	120	nS
OLP (Over Load Protection)						
TLOLP	OLP Trip Level			5.0		V
TDOLP	OLP Delay Time (note)			60		mS

Note: The OLP delay time is proportional to the period of switching cycle. So that, the lower RT value will set the higher switching frequency and the shorter OLP delay time.

PERFPRMANCE CHARACTERISTICS (TA=25°C unless otherwise specific)

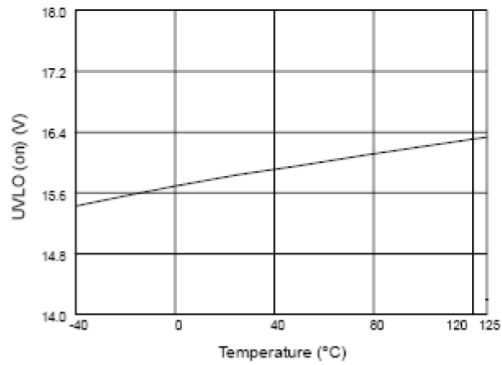


Fig. 1 UVLO (on) vs. Temperature

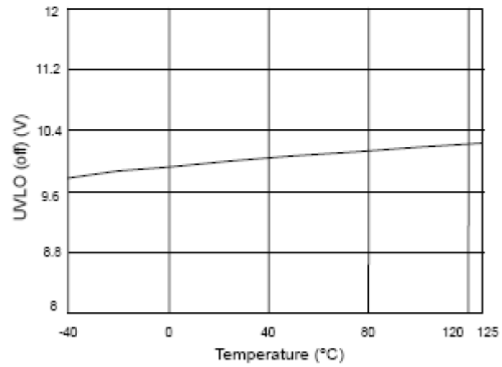


Fig. 2 UVLO (off) vs. Temperature

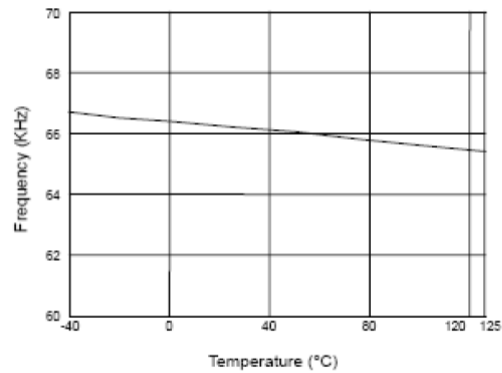


Fig. 3 Frequency vs. Temperature

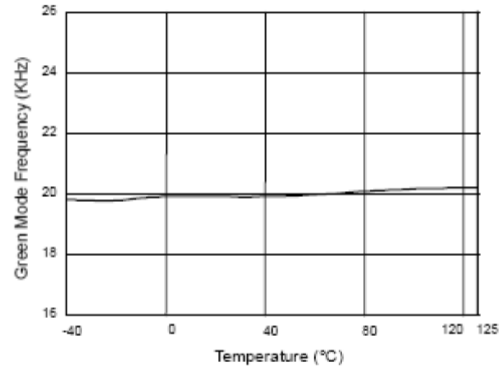


Fig. 4 Green Mode Frequency vs. Temperature

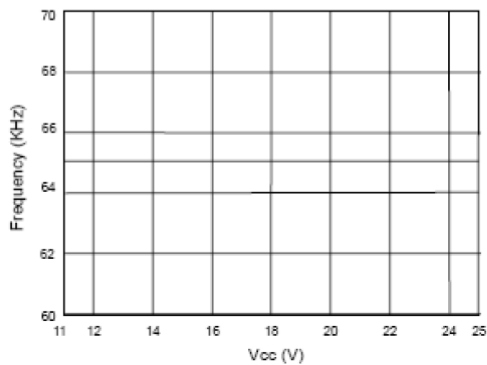


Fig. 5 Frequency vs. Vcc

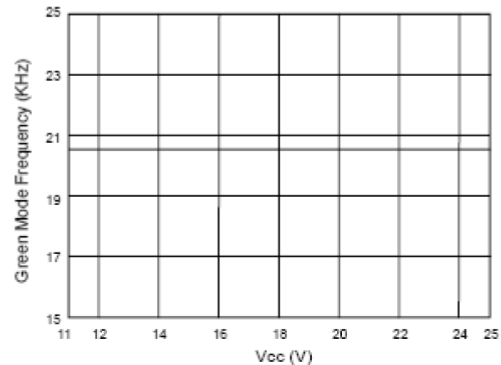


Fig. 6 Green Mode Frequency vs. Vcc

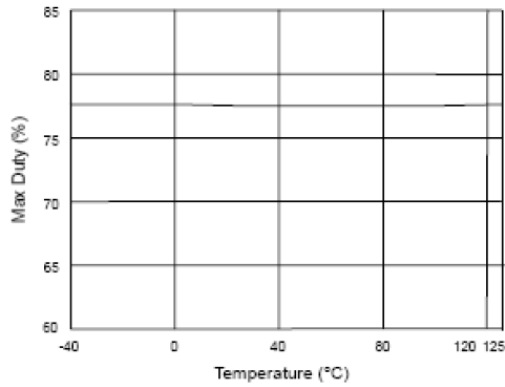
PERFORMANCE CHARACTERISTICS ($T_A=25^\circ\text{C}$ unless otherwise specified)


Fig. 7 Max Duty vs. Temperature

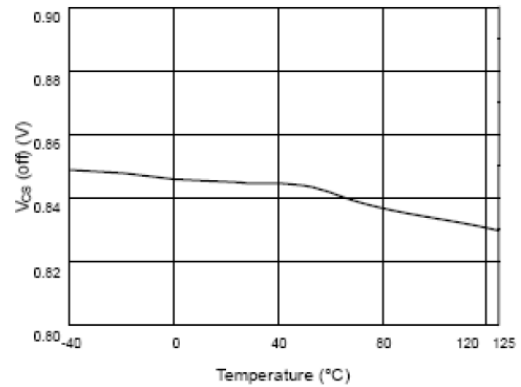
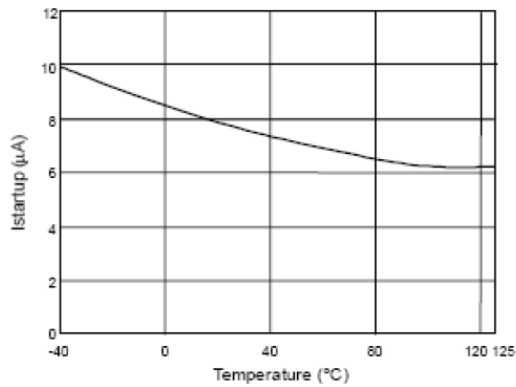
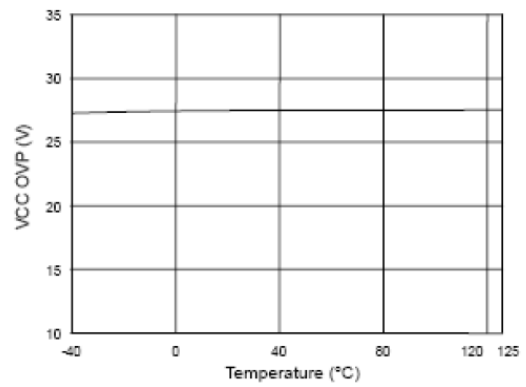

 Fig. 8 $V_{CS}(\text{off})$ vs. Temperature

 Fig. 9 Startup Current (I_{startup}) vs. Temperature


Fig. 10 VCC OVP vs. Temperature

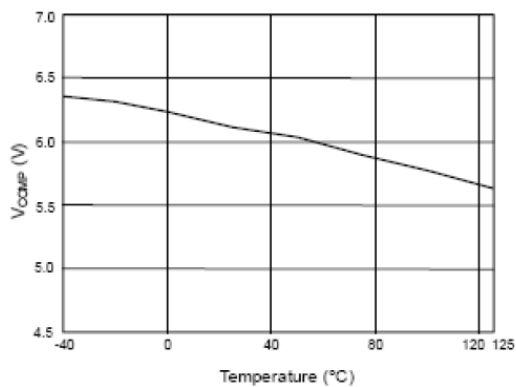
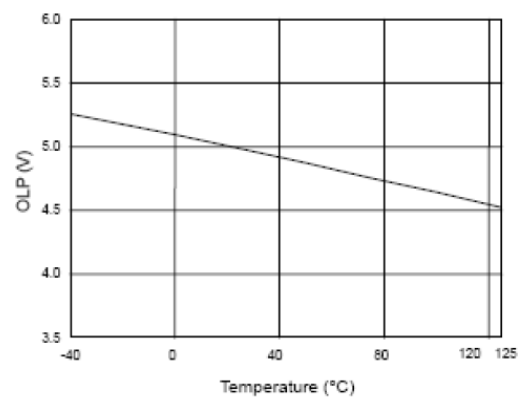
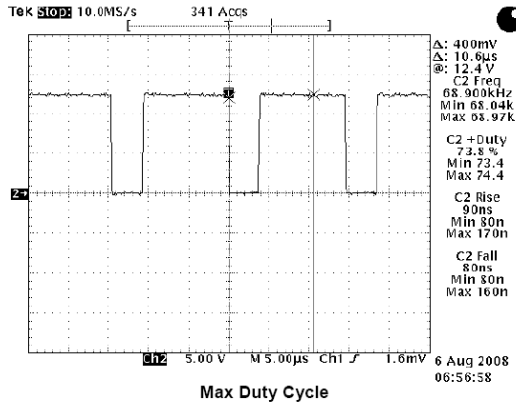
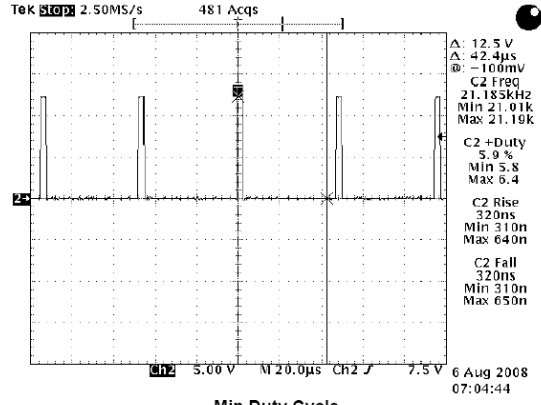

 Fig. 11 V_{comp} open loop voltage vs. Temperature


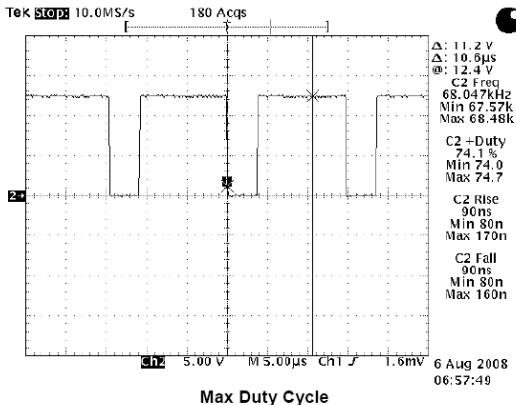
Fig. 12 OLP-Trip Level vs. Temperature

PERFORMANCE CHARACTERISTICS (TA=25°C unless otherwise specified)


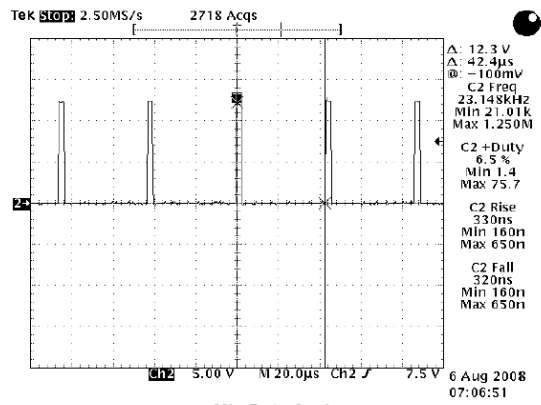
Max Duty Cycle



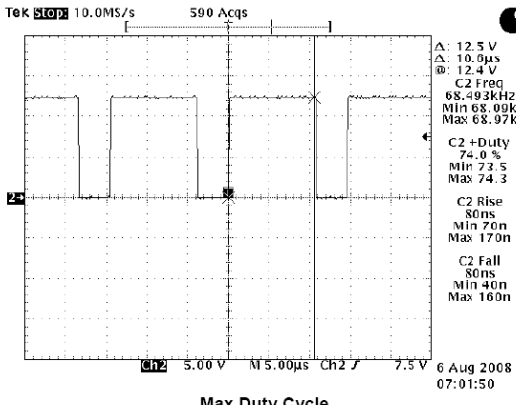
Min Duty Cycle



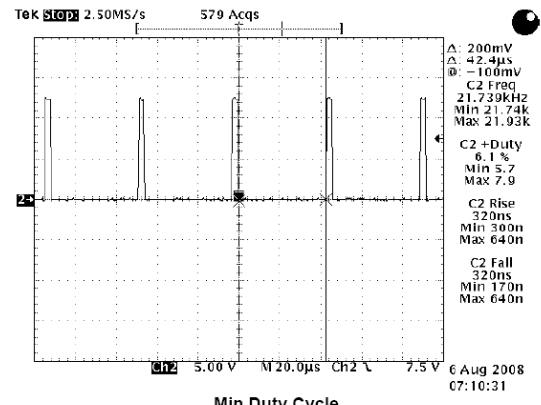
Max Duty Cycle



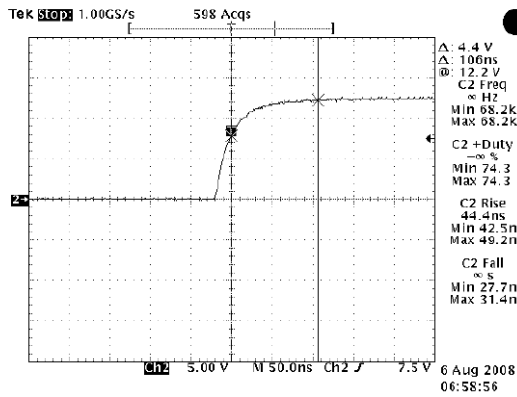
Min Duty Cycle



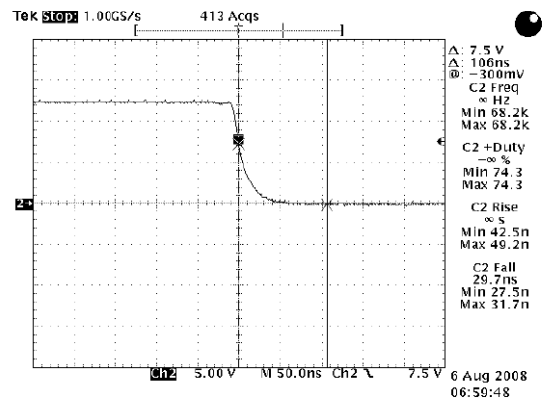
Max Duty Cycle



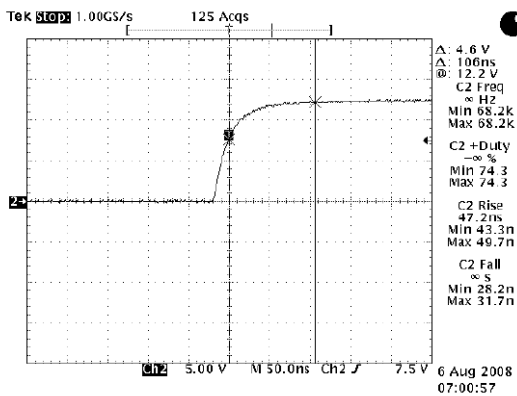
Min Duty Cycle

PERFORMANCE CHARACTERISTICS (TA=25°C unless otherwise specified)


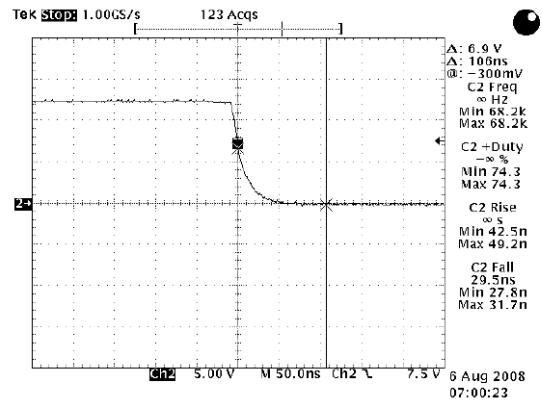
Rising Time Load



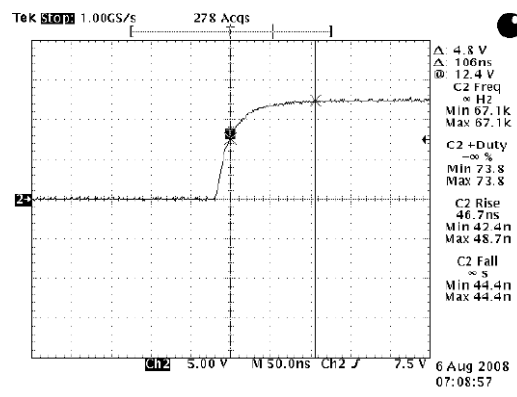
Falling Time Load



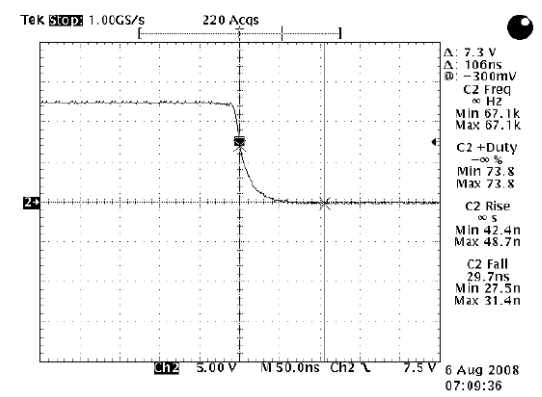
Rising Time Load



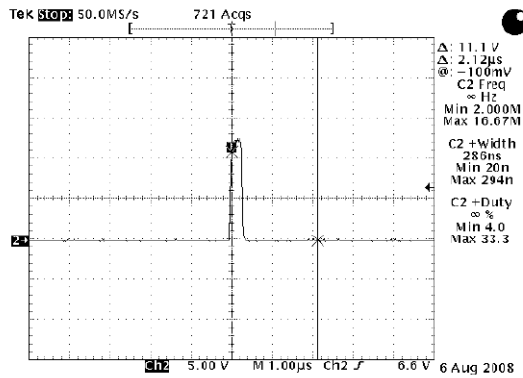
Falling Time Load



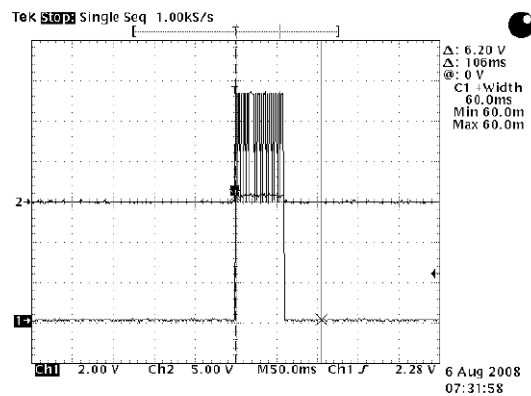
Rising Time Load



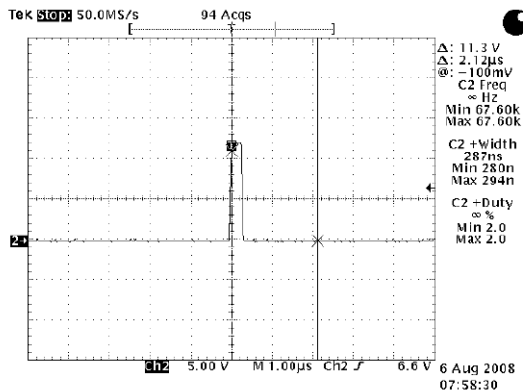
Falling Time Load

PERFORMANCE CHARACTERISTICS (TA=25°C unless otherwise specific)


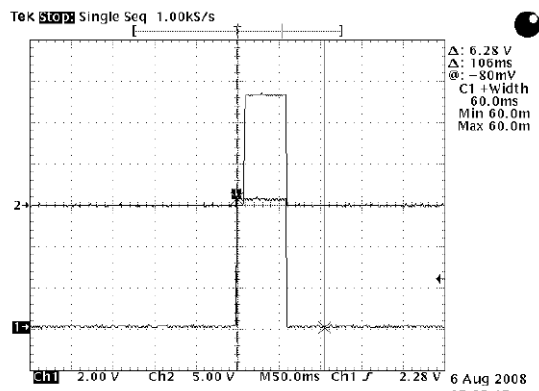
Leading Edge Blanking Time



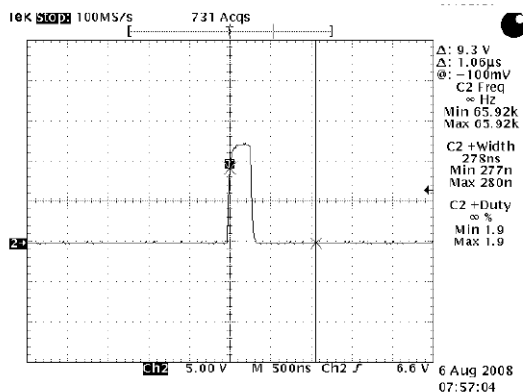
OLP Delay Time



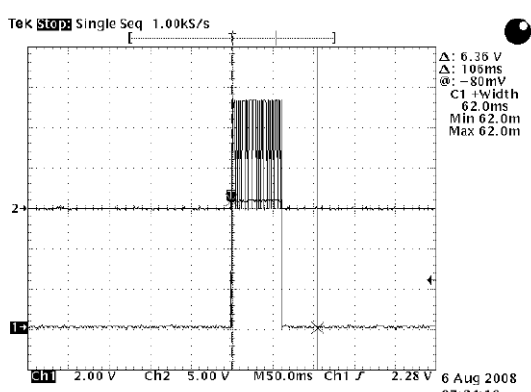
Leading Edge Blanking Time



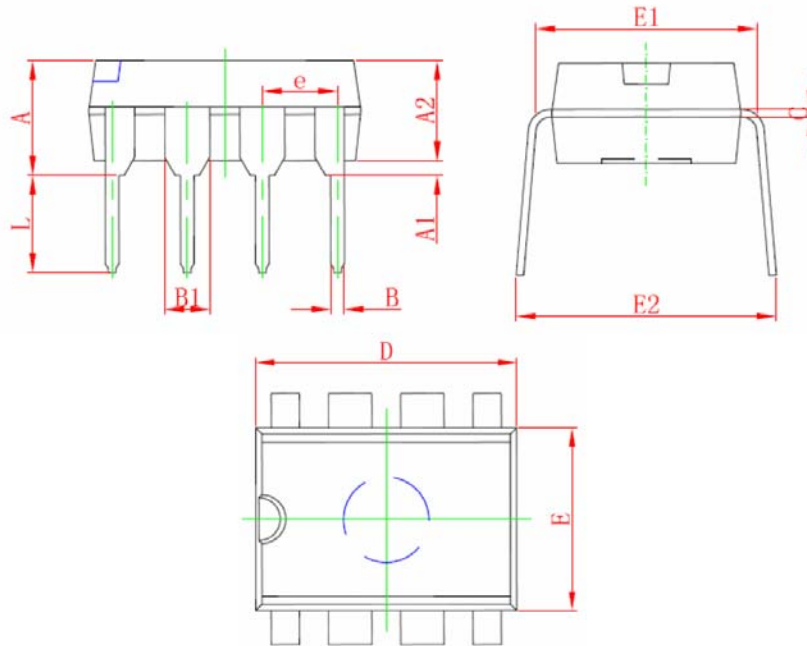
OLP Delay Time



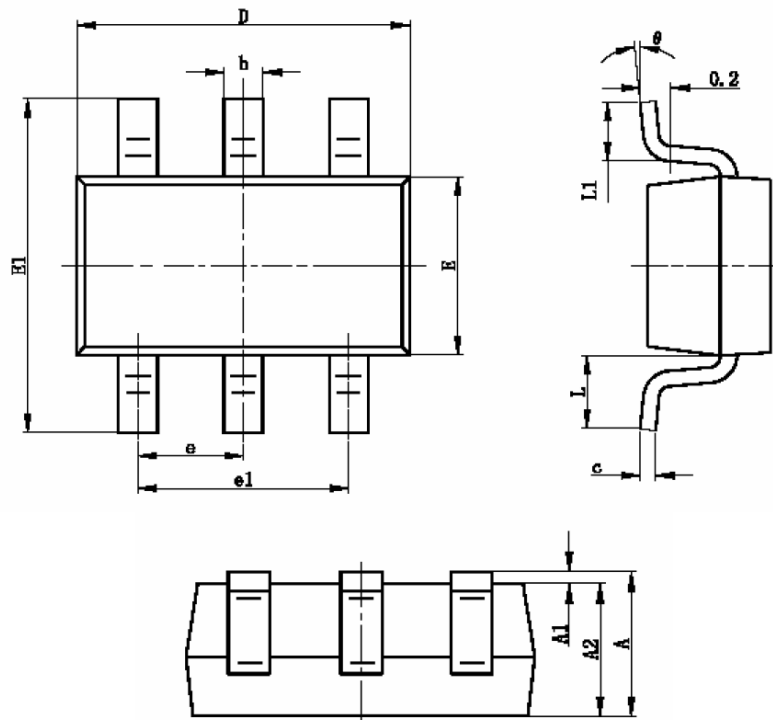
Leading Edge Blanking Time



OLP Delay Time

DIP-8 PACKAGE OUTLING


Symbol	Dimensions In Millimeters		Dimensions In Inches	
	Min	Max	Min	Max
A	3.710	4.310	0.146	0.170
A1	0.510		0.020	
A2	3.200	3.600	0.126	0.142
B	0.380	0.570	0.015	0.022
B1	1.524 (BSC)		0.060 (BSC)	
C	0.204	0.360	0.008	0.014
D	9.000	9.400	0.354	0.370
E	6.200	6.600	0.244	0.260
E1	7.320	7.920	0.288	0.312
e	2.540 (BSC)		0.100 (BSC)	
L	3.000	3.600	0.118	0.142
E2	8.400	9.000	0.331	0.354

SOT23-6L PACKAGE OUTLING


Symbol	Dimensions In Millimeters		Dimensions In Inches	
	Min	Max	Min	Max
A	1.050	1.250	0.041	0.049
A1	0.000	0.100	0.000	0.004
A2	1.050	1.150	0.041	0.045
b	0.300	0.400	0.012	0.016
c	0.100	0.200	0.004	0.008
D	2.820	3.020	0.111	0.119
E	1.500	1.700	0.059	0.067
E1	2.650	2.950	0.104	0.116
e	0.950TYP		0.037TYP	
e1	1.800	2.000	0.071	0.079
L	0.700REF		0.028REF	
L1	0.300	0.600	0.012	0.024
theta	0°	8°	0°	8°