

DESCRIPTION

STN4110 is used trench technology to provide excellent RDS(on) and gate charge. Those devices are ideal for boost converters and synchronous rectifiers for consumer, telecom, industrial power supplies and LED backlighting.

PIN CONFIGURATION (D-PAK)

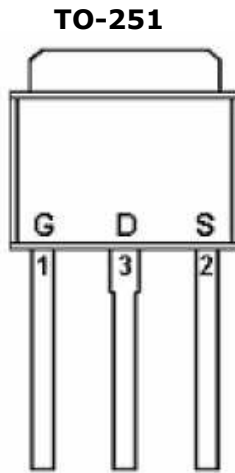
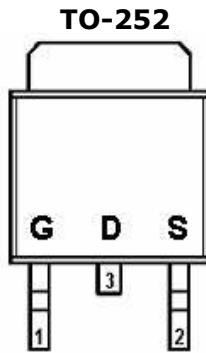

FEATURE

- 60V/20.0A, $R_{DS(ON)} = 10m\Omega$ (Typ.) @ $V_{GS} = 10V$
- 60V/20.0A, $R_{DS(ON)} = 12m\Omega$ @ $V_{GS} = 4.5V$
- Super high density cell design for extremely low $R_{DS(ON)}$
- Exceptional on-resistance and maximum DC current capability
- TO-252, TO-251 package design

PART MARKING

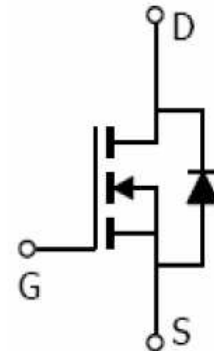
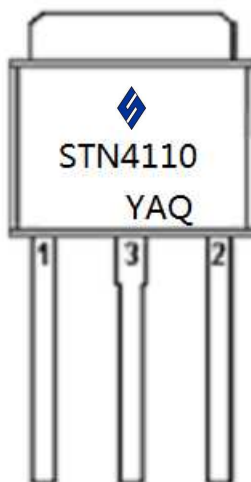

Y: Year Code A: Date Code Q: Process Code

**STN4110**

N Channel Enhancement Mode MOSFET

40.0A

ABSOLUTE MAXIMUM RATINGS (Ta = 25°C Unless otherwise noted)

Parameter	Symbol	Typical	Unit
Drain-Source Voltage	VDSS	60	V
Gate-Source Voltage	VGSS	±20	V
Continuous Drain Current (TJ=150°C)	ID	TA=25°C 40.0	A
		TA=70°C 40.0	
Pulsed Drain Current	IDM	180	A
Continuous Source Current (Diode Conduction)	IS	46	A
Power Dissipation	PD	TA=25°C 63	W
		TA=70°C 31	
Operation Junction Temperature	TJ	175	°C
Storage Temperature Range	TSTG	-55/175	°C
Thermal Resistance-Junction to Ambient	RθJA	16	°C/W

ELECTRICAL CHARACTERISTICS (Ta = 25°C Unless otherwise noted)

Parameter	Symbol	Condition	Min	Typ	Max	Unit
Static						
Drain-Source Breakdown Voltage	$V_{(BR)DSS}$	$V_{GS}=0V, I_D=250mA$	60			V
Gate Threshold Voltage	$V_{GS(th)}$	$V_{DS}=V_{GS}, I_D=250\mu A$	1		3	V
Gate Leakage Current	I_{GSS}	$V_{DS}=0V, V_{GS}=\pm 20V$			0.1	μA
Zero Gate Voltage Drain Current	I_{DSS}	$V_{DS}=60V, V_{GS}=0V$			1	nA
		$V_{DS}=48V, V_{GS}=0V$ $T_J=55^\circ C$			5	
Drain-source On-Resistance	$R_{DS(on)}$	$V_{GS}=10V, I_D=20A$ $V_{GS}=4.5V, I_D=20A$		10 12	12 15	$m\Omega$
Forward Transconductance	g_{fs}	$V_{DS}=5V, I_D=20A$		55		S
Diode Forward Voltage	V_{SD}	$I_S=1.0A, V_{GS}=0V$		0.65	1.0	V
Dynamic						
Total Gate Charge	Q_g	$V_{GS}=10V, V_{DS}=20V$ $I_D=20A$		29	35	nC
Gate-Source Charge	Q_{gs}			4.8		
Gate-Drain Charge	Q_{gd}			7.8		
Input Capacitance	C_{iss}	$V_{DS}=20V, V_{GS}=0V$ $F=1MHz$		1590	1800	pF
Output Capacitance	C_{oss}			105		
Reverse Transfer Capacitance	C_{rss}			69		
Turn-On Time	$t_{d(on)}$	$V_{DS}=20V, V_{GS}=10V$ $R_L=0.75\Omega$ $V_{GEN}=3\Omega$		7.8		nS
	t_r			6.5		
Turn-Off Time	$t_{d(off)}$			33		
	t_f			7.5		

TYPICAL CHARACTERISTICS

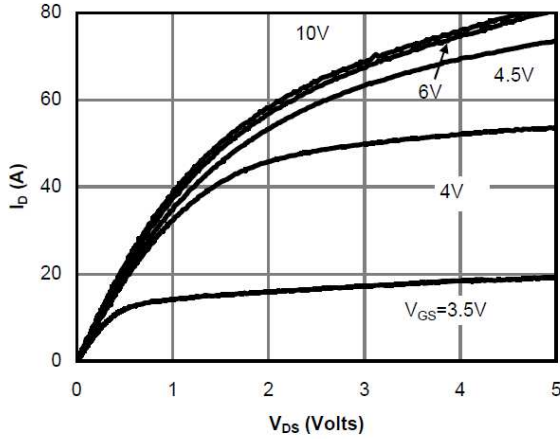

Fig 1: On-Region Characteristics (Note E)

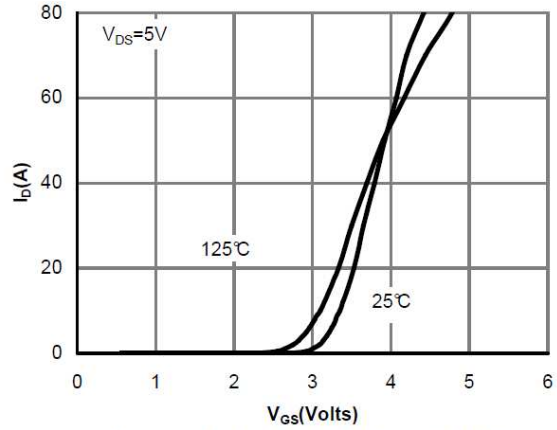

Figure 2: Transfer Characteristics (Note E)

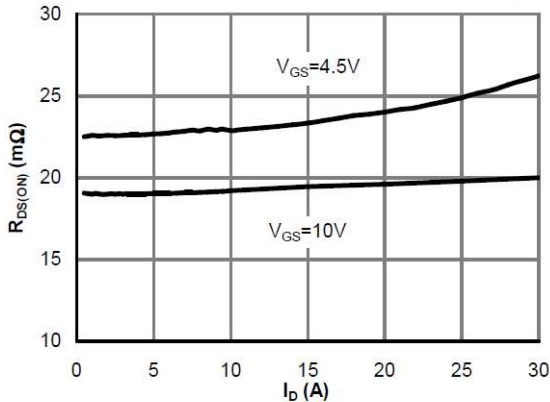

Figure 3: On-Resistance vs. Drain Current and Gate Voltage (Note E)

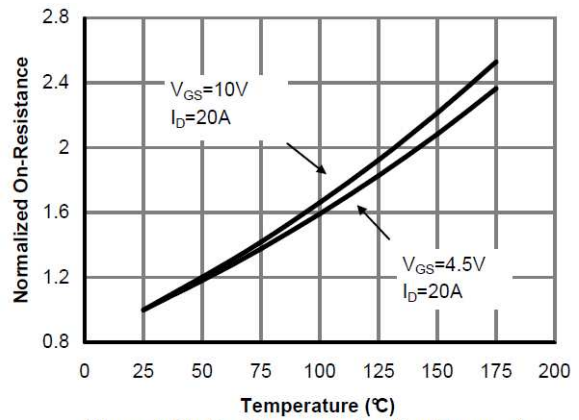

Figure 4: On-Resistance vs. Junction Temperature (Note E)

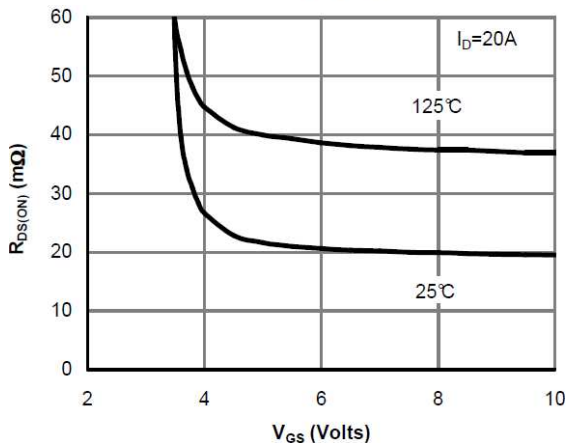

Figure 5: On-Resistance vs. Gate-Source Voltage (Note E)

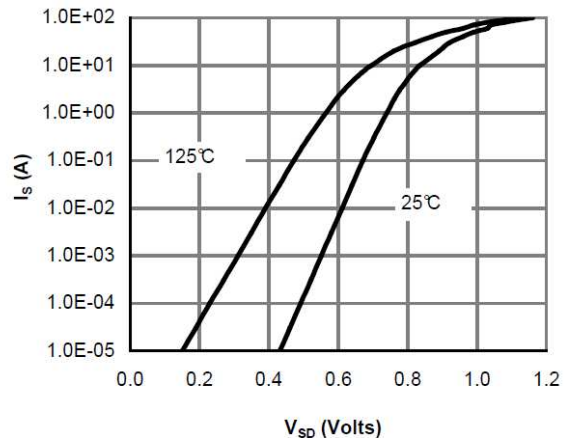

Figure 6: Body-Diode Characteristics (Note E)

TYPICAL CHARACTERISTICS

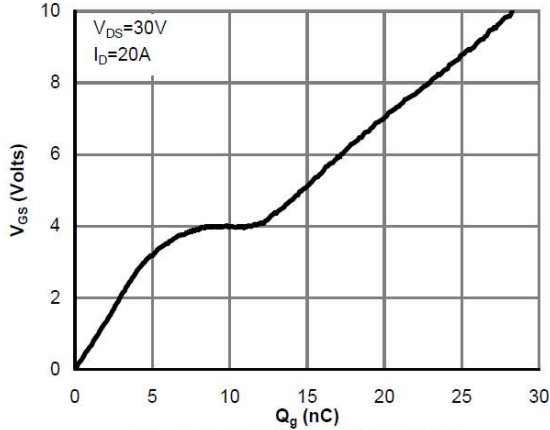

Figure 7: Gate-Charge Characteristics

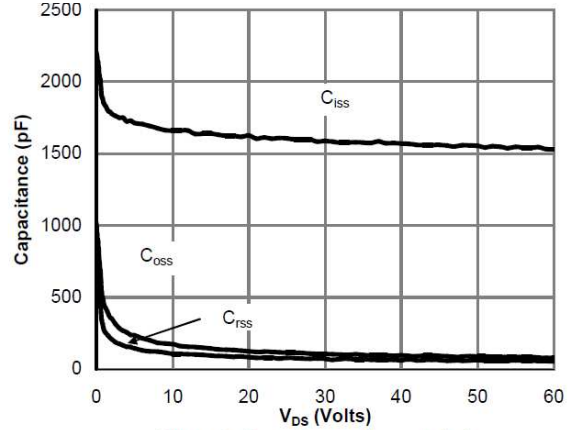

Figure 8: Capacitance Characteristics

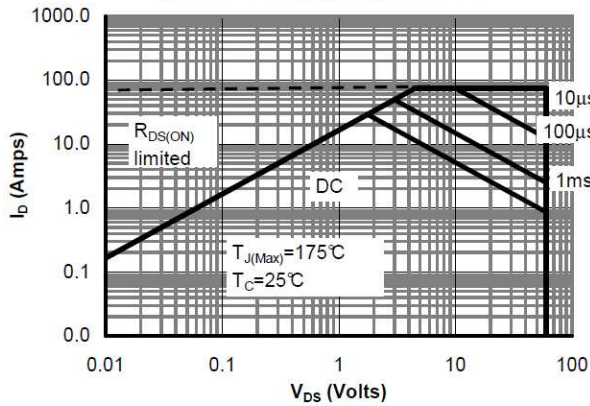

Figure 9: Maximum Forward Biased Safe Operating Area (Note F)

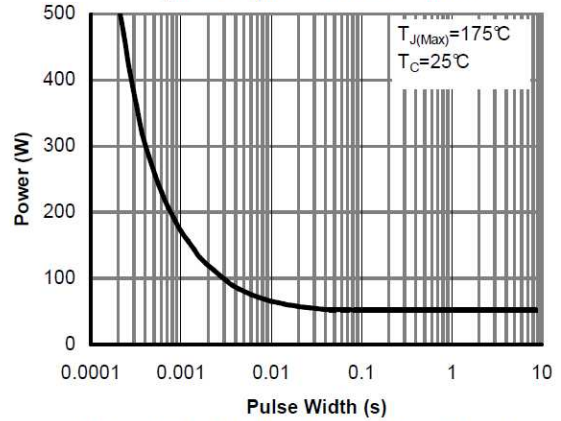

Figure 10: Single Pulse Power Rating Junction-to-Case (Note F)

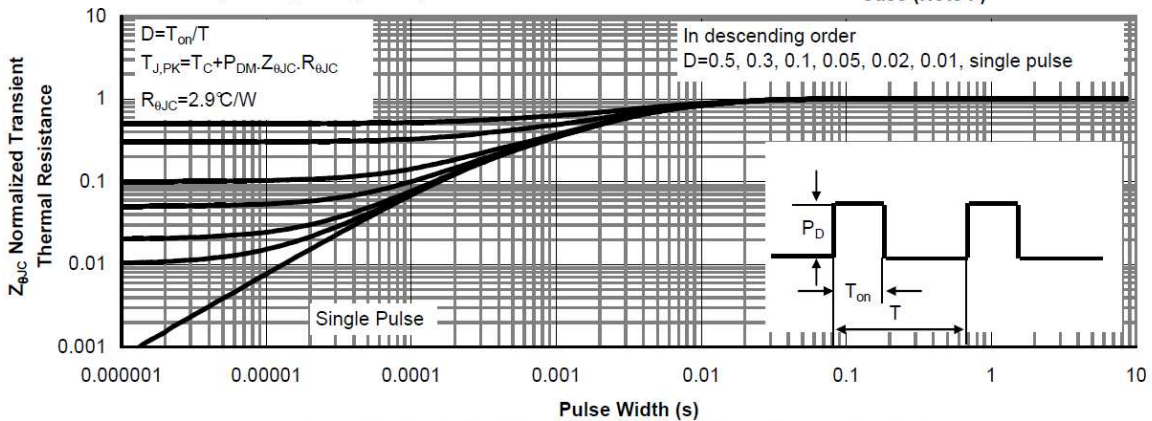

Figure 11: Normalized Maximum Transient Thermal Impedance (Note F)

TYPICAL CHARACTERISTICS

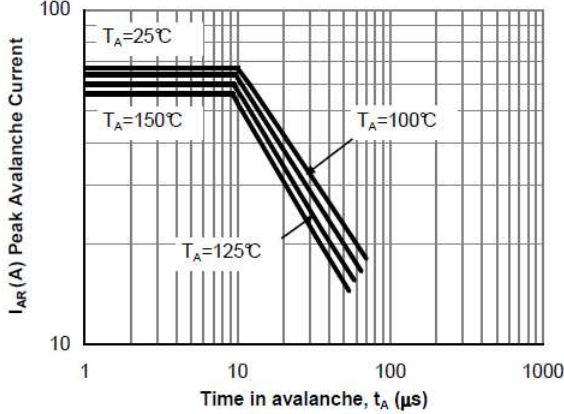

Figure 12: Single Pulse Avalanche capability (Note C)

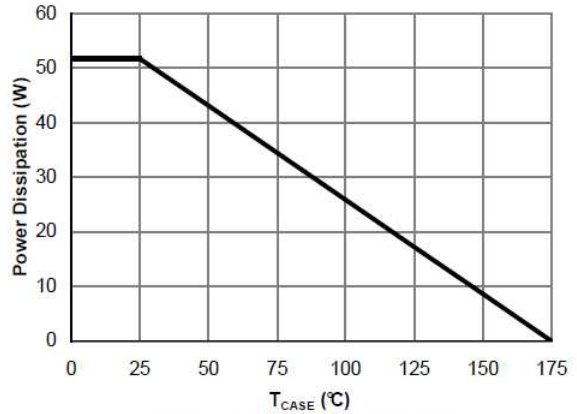

Figure 13: Power De-rating (Note F)

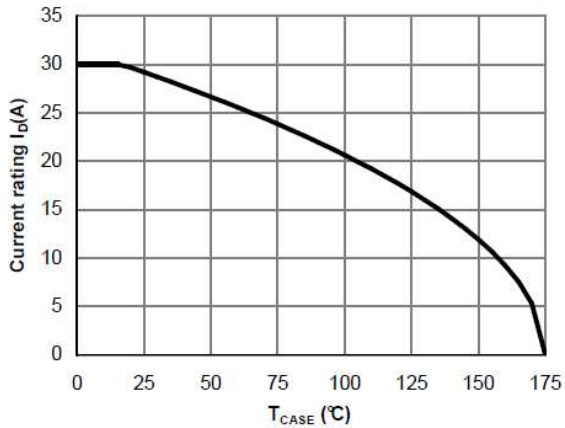

Figure 14: Current De-rating (Note F)

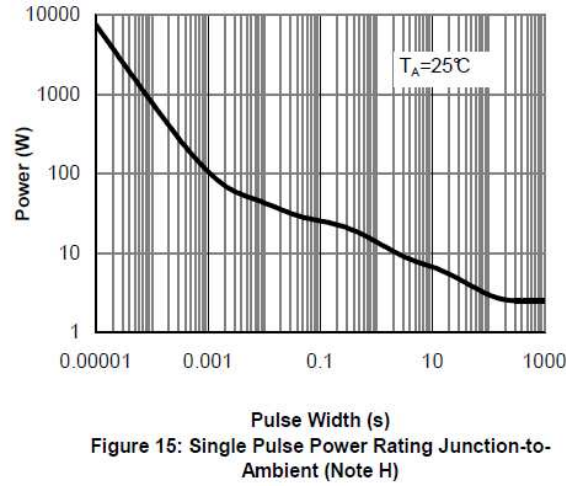

Figure 15: Single Pulse Power Rating Junction-to-Ambient (Note H)

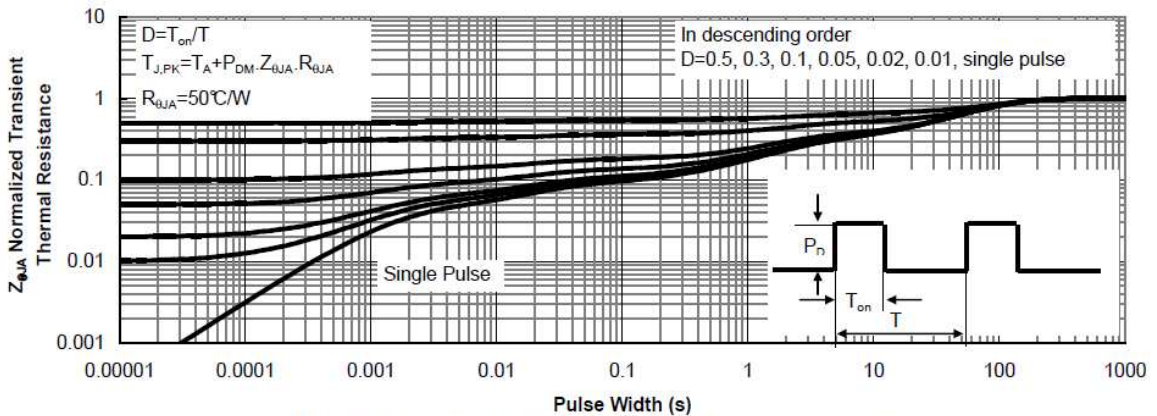
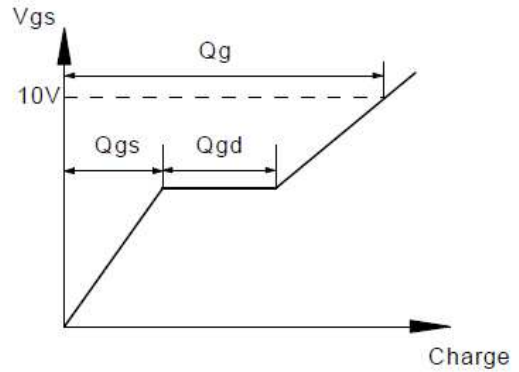
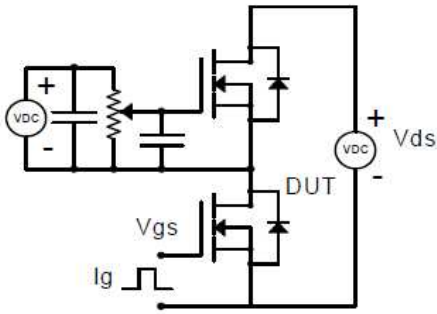
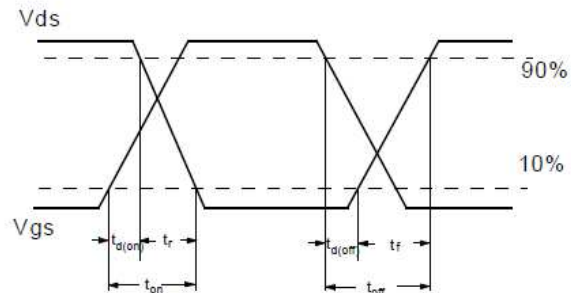
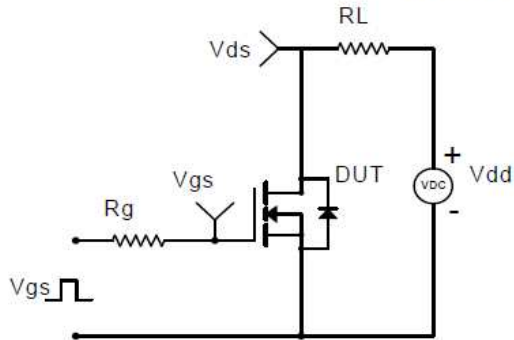

Figure 16: Normalized Maximum Transient Thermal Impedance (Note H)

Gate Charge Test Circuit & Waveform



Resistive Switching Test Circuit & Waveforms



Unclamped Inductive Switching (UIS) Test Circuit & Waveforms

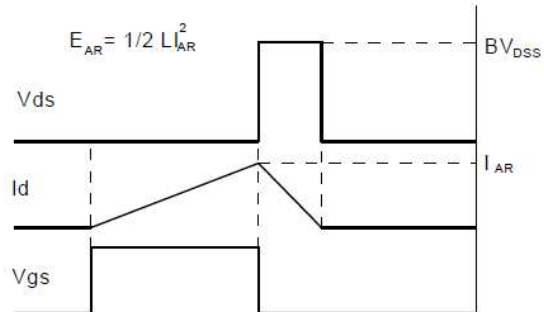
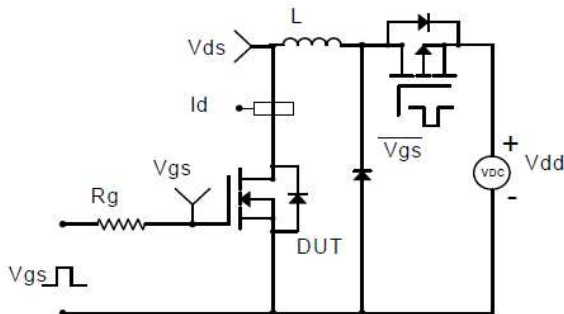

TO-252-2L PACKAGE OUTLINE SOP-8P

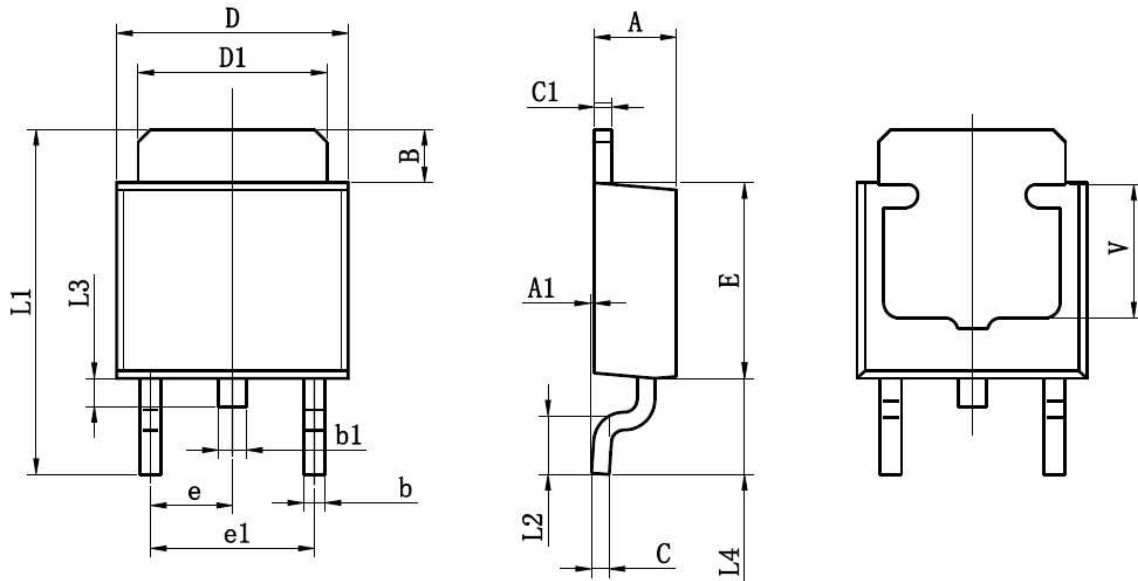

Symbol	Dimensions In Millimeters		Dimensions In Inches	
	Min	Max	Min	Max
A	2.200	2.400	0.087	0.094
A1	0.000	0.127	0.000	0.005
B	1.350	1.650	0.053	0.065
b	0.500	0.700	0.020	0.028
b1	0.700	0.900	0.028	0.035
c	0.430	0.580	0.017	0.023
c1	0.430	0.580	0.017	0.023
D	6.350	6.650	0.250	0.262
D1	5.200	5.400	0.205	0.213
E	5.400	5.700	0.213	0.224
e	2.300TYP		0.091TYP	
e1	4.500	4.700	0.177	0.185
L1	9.500	9.900	0.374	0.390
L2	1.400	1.780	0.055	0.070
L3	0.650	0.950	0.026	0.037
L4	2.550	2.900	0.100	0.114
V	3.80REF		0.150REF	