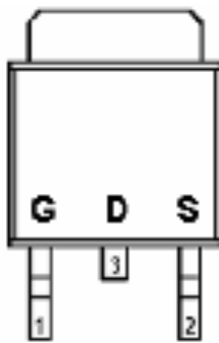


**DESCRIPTION**

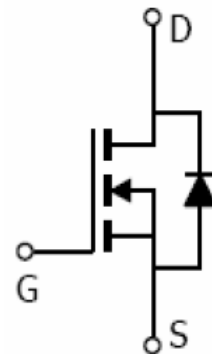
STN4130 is used trench technology to provide excellent  $R_{DS(on)}$  and gate charge. Those devices are ideal for boost converters and synchronous rectifiers for consumer, telecom, industrial power supplies and LED backlighting.

**PIN CONFIGURATION (D-PAK)**
**TO-252**

**FEATURE**

- 60V/20.0A,  $R_{DS(ON)} = 40m\Omega$  (Typ.) @ $V_{GS} = 10V$
- 60V/20.0A,  $R_{DS(ON)} = 50m\Omega$  @ $V_{GS} = 4.5V$
- Super high density cell design for extremely low  $R_{DS(ON)}$
- Exceptional on-resistance and maximum DC current capability
- TO-252 package design

**PART MARKING**


**Y : Year Code**  
**A : Date Code**  
**B : Wafer Code**



**STN4130**

N Channel Enhancement Mode MOSFET

30.0A

**ABSOLUTE MAXIMUM RATINGS** (Ta = 25°C Unless otherwise noted )

Parameter	Symbol	Typical	Unit
Drain-Source Voltage	VDSS	60	V
Gate-Source Voltage	VGSS	±20	V
Continuous Drain Current (TJ=150°C)	ID	30.0 20.0	A
Pulsed Drain Current	IDM	74	A
Continuous Source Current (Diode Conduction)	IS	46	A
Power Dissipation	PD	52 25	W
Operation Junction Temperature	TJ	175	°C
Storage Temperature Range	TSTG	-55/175	°C
Thermal Resistance-Junction to Ambient	RθJA	13	°C/W

**ELECTRICAL CHARACTERISTICS** ( Ta = 25°C Unless otherwise noted )

Parameter	Symbol	Condition	Min	Typ	Max	Unit	
<b>Static</b>							
Drain-Source Breakdown Voltage	$V_{(BR)DSS}$	$V_{GS}=0V, I_D=250mA$	60			V	
Gate Threshold Voltage	$V_{GS(th)}$	$V_{DS}=V_{GS}, I_D=250\mu A$	1		2.5	V	
Gate Leakage Current	$I_{GSS}$	$V_{DS}=0V, V_{GS}=\pm 20V$			100	nA	
Zero Gate Voltage Drain Current	$I_{DSS}$	$V_{DS}=60V, V_{GS}=0V$			1	uA	
		$V_{DS}=48V, V_{GS}=0V$ $T_J=55^\circ C$			5		
Drain-source On-Resistance	$R_{DS(on)}$	$V_{GS}=10V, I_D=20A$ $V_{GS}=4.5V, I_D=20A$		40 50	47 58	mΩ	
Forward Transconductance	$g_{fs}$	$V_{DS}=5V, I_D=20A$		55		S	
Diode Forward Voltage	$V_{SD}$	$I_S=3.0A, V_{GS}=0V$			1.0	V	
<b>Dynamic</b>							
Total Gate Charge	$Q_g$	$V_{DS}=10V, V_{DS}=30V$ $I_D=20A$			34	nC	
Gate-Source Charge	$Q_{gs}$				16		
Gate-Drain Charge	$Q_{gd}$				5.4		
Input Capacitance	$C_{iss}$	$V_{DS}=30V, V_{GS}=0V$ $F=1MHz$		1600		pF	
Output Capacitance	$C_{oss}$			100			
Reverse Transfer Capacitance	$C_{rss}$			68			
Turn-On Time	$t_{d(on)}$	$V_{DS}=30V, V_{GS}=10V$ $R_L=1.5\Omega$ $I_D=5.0A, V_{GEN}=3V$		7.5		nS	
	$t_r$			6.5			
Turn-Off Time	$t_{d(off)}$				33		
	$t_f$				7.5		

**TYPICAL CHARACTERISTICS**

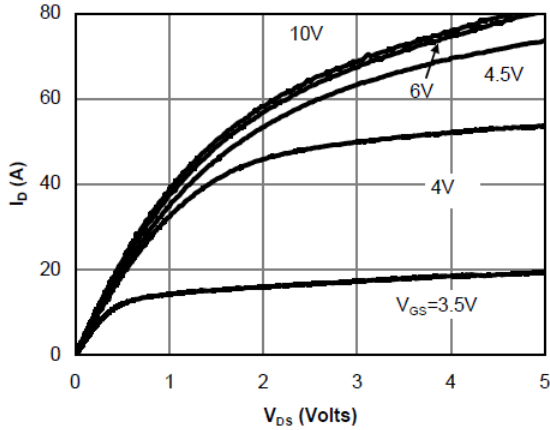


Fig 1: On-Region Characteristics (Note E)

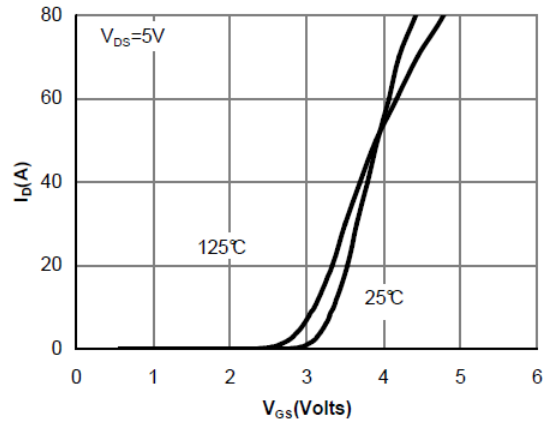


Figure 2: Transfer Characteristics (Note E)

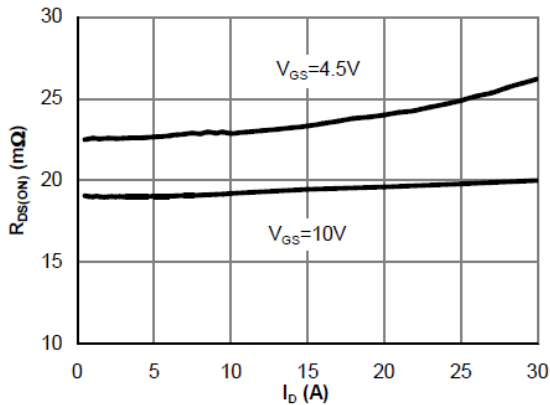


Figure 3: On-Resistance vs. Drain Current and Gate Voltage (Note E)

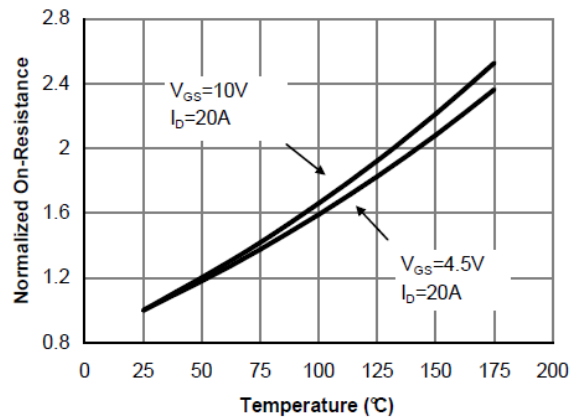


Figure 4: On-Resistance vs. Junction Temperature (Note E)

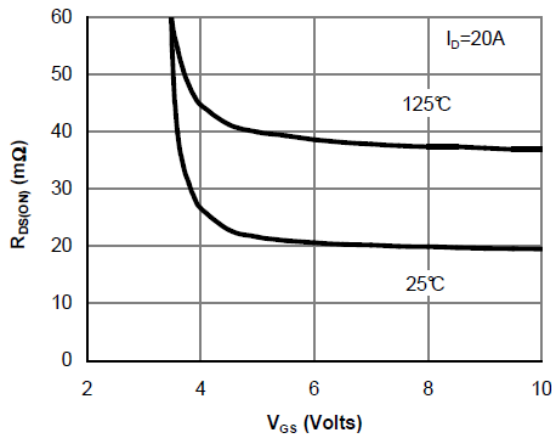


Figure 5: On-Resistance vs. Gate-Source Voltage (Note E)

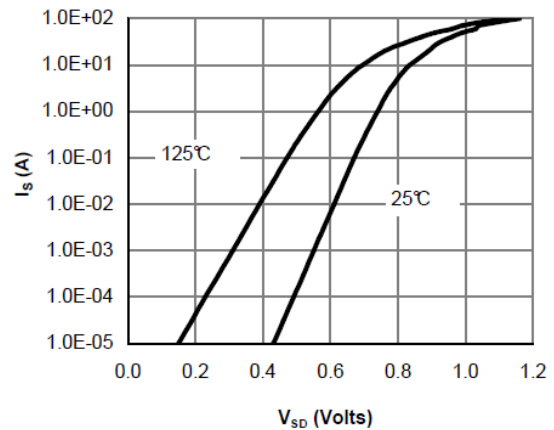


Figure 6: Body-Diode Characteristics (Note E)

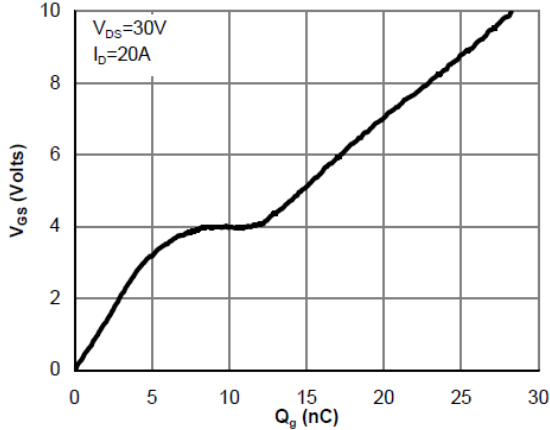
**TYPICAL CHARACTERISTICS**


Figure 7: Gate-Charge Characteristics

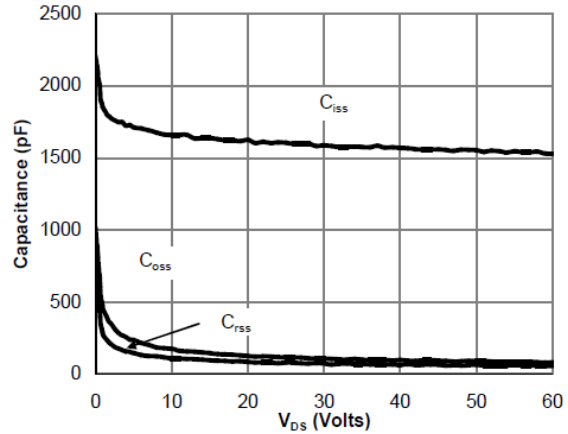


Figure 8: Capacitance Characteristics

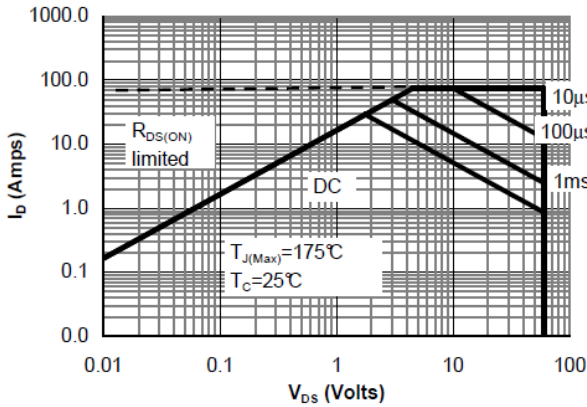


Figure 9: Maximum Forward Biased Safe Operating Area (Note F)

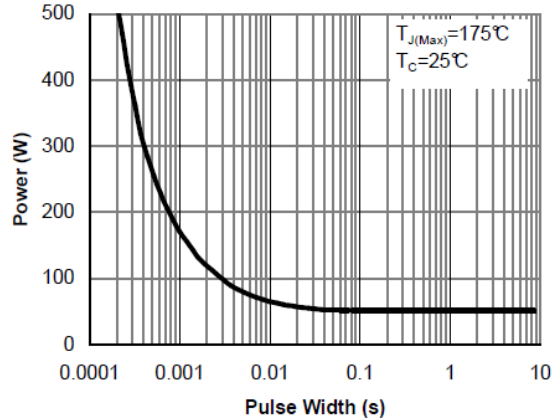


Figure 10: Single Pulse Power Rating Junction-to-Case (Note F)

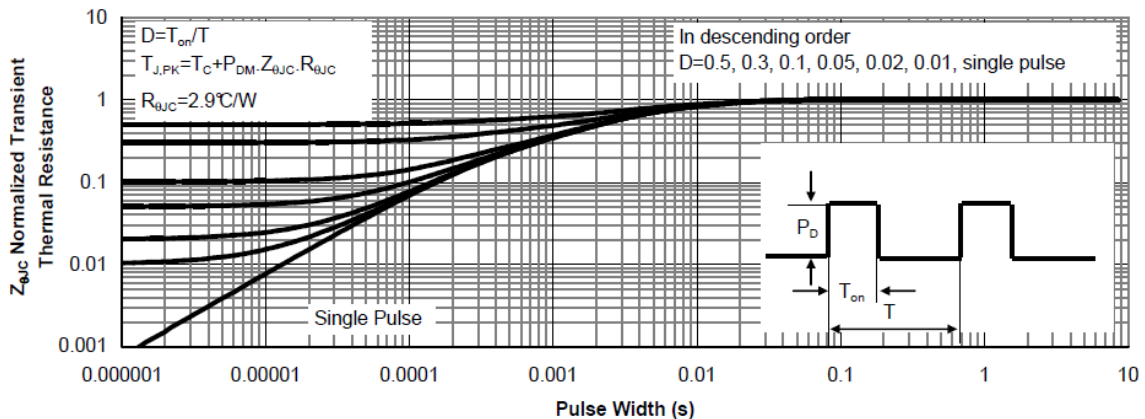


Figure 11: Normalized Maximum Transient Thermal Impedance (Note F)

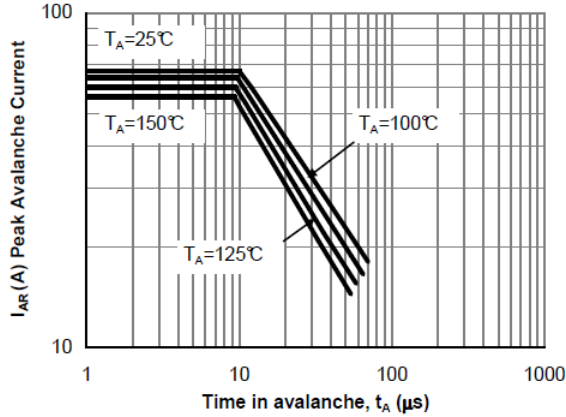
**TYPICAL CHARACTERISTICS**


Figure 12: Single Pulse Avalanche capability (Note C)

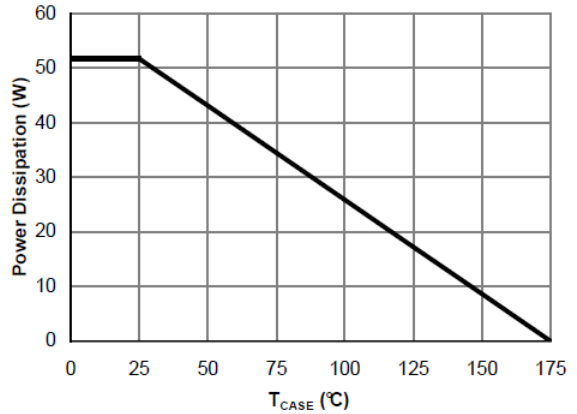


Figure 13: Power De-rating (Note F)

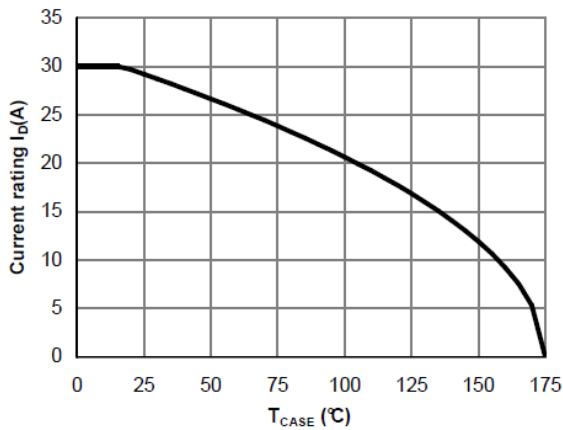


Figure 14: Current De-rating (Note F)

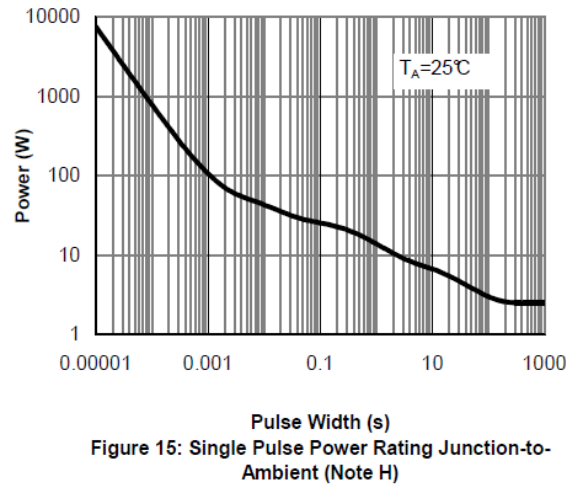


Figure 15: Single Pulse Power Rating Junction-to-Ambient (Note H)

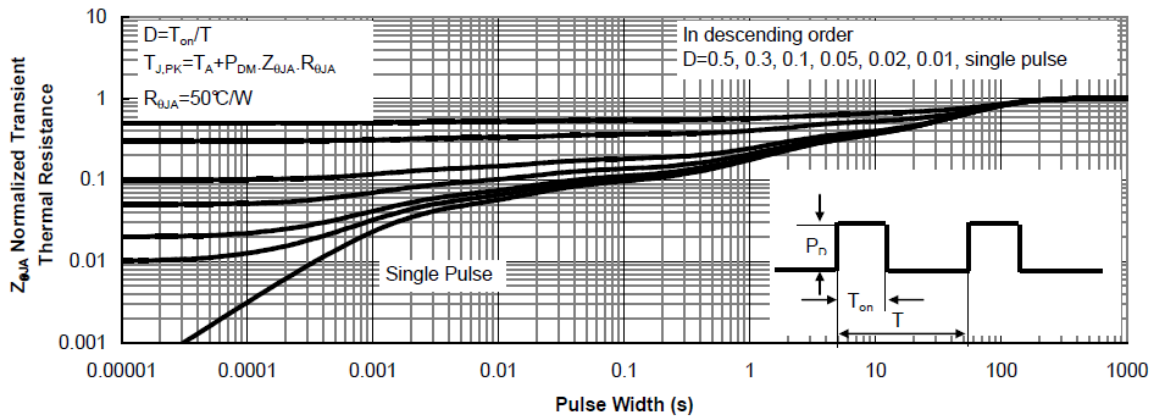
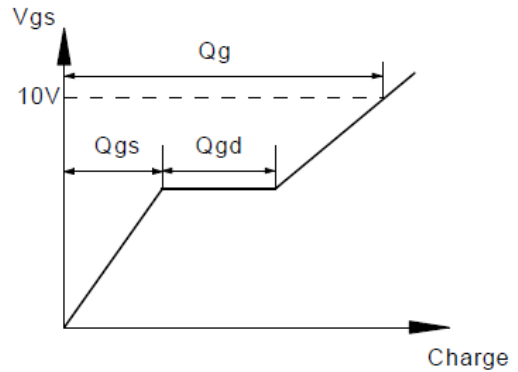
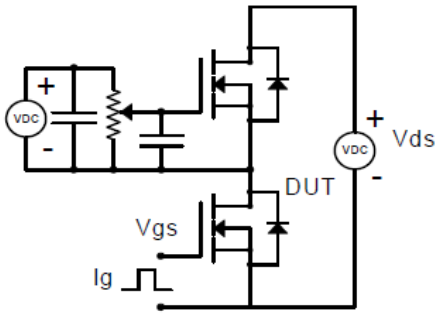
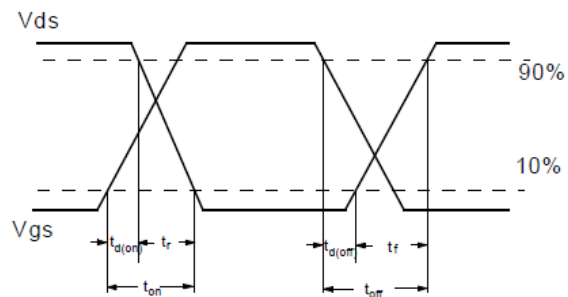
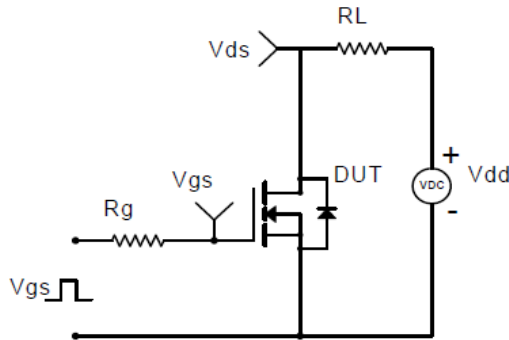


Figure 16: Normalized Maximum Transient Thermal Impedance (Note H)

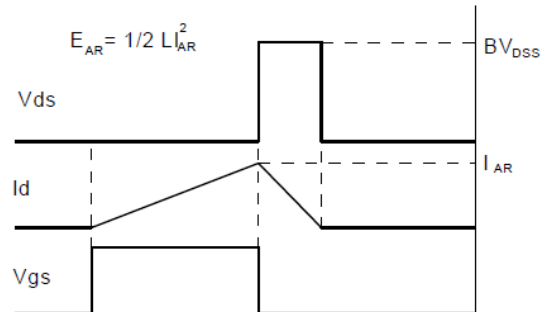
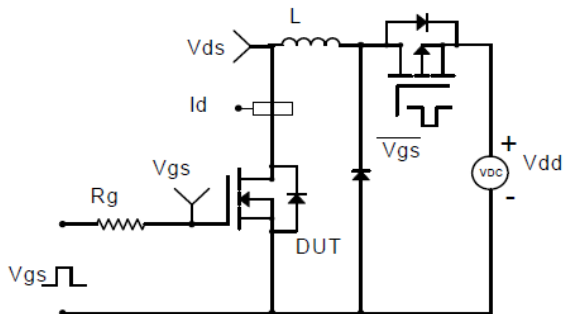
**Gate Charge Test Circuit & Waveform**

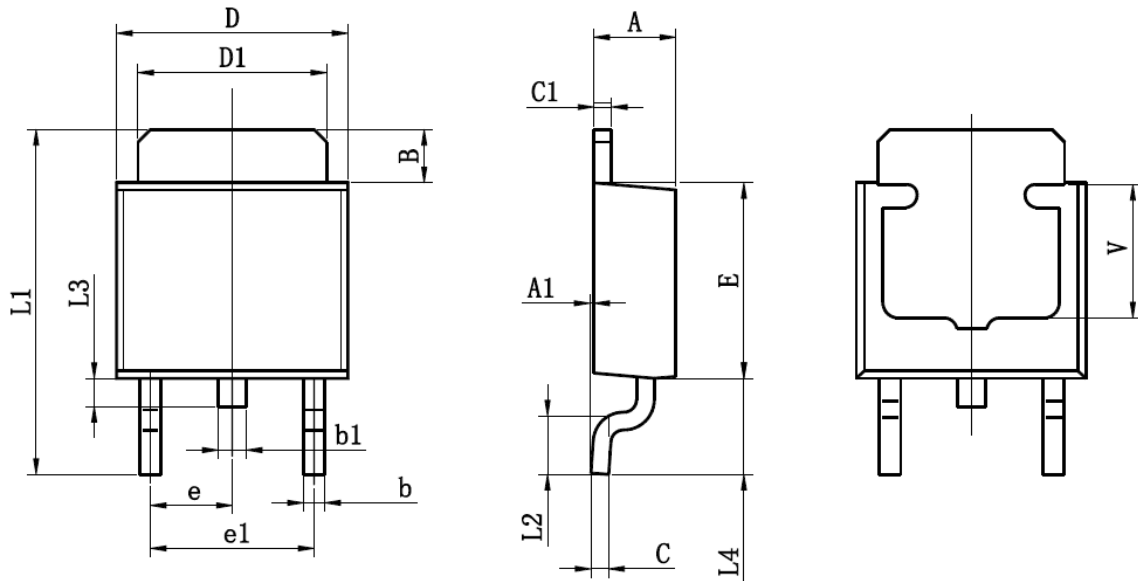


**Resistive Switching Test Circuit & Waveforms**



**Unclamped Inductive Switching (UIS) Test Circuit & Waveforms**



**TO-252-2L PACKAGE OUTLINE**


Symbol	Dimensions In Millimeters		Dimensions In Inches	
	Min	Max	Min	Max
A	2.200	2.400	0.087	0.094
A1	0.000	0.127	0.000	0.005
B	1.350	1.650	0.053	0.065
b	0.500	0.700	0.020	0.028
b1	0.700	0.900	0.028	0.035
c	0.430	0.580	0.017	0.023
c1	0.430	0.580	0.017	0.023
D	6.350	6.650	0.250	0.262
D1	5.200	5.400	0.205	0.213
E	5.400	5.700	0.213	0.224
e	2.300TYP		0.091TYP	
e1	4.500	4.700	0.177	0.185
L1	9.500	9.900	0.374	0.390
L2	1.400	1.780	0.055	0.070
L3	0.650	0.950	0.026	0.037
L4	2.550	2.900	0.100	0.114
V	3.80REF		0.150REF	