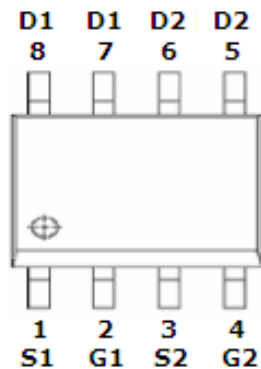

**DESCRIPTION**

STP4953 is the dual P-Channel logic enhancement mode power field effect transistor which is produced using high cell density, DMOS trench technology. This high density process is especially tailored to minimize on-state resistance. These devices are particularly suited for low voltage application such as LCD backlight, notebook computer power management, and other battery powered circuits.

**PIN CONFIGURATION**
**SOP-8**

**FEATURE**

- -30V/-5.2A,  $R_{DS(ON)} = 60m\Omega$  @ $V_{GS} = -10V$
- -30V/-4.5A,  $R_{DS(ON)} = 80m\Omega$  @ $V_{GS} = -6.0V$
- -30V/-3.8A,  $R_{DS(ON)} = 90m\Omega$  @ $V_{GS} = -4.5V$
- Super high density cell design for extremely low  $R_{DS(ON)}$
- Exceptional on-resistance and maximum DC current capability
- SOP-8 package design

**PART MARKING**
**SOP-8**

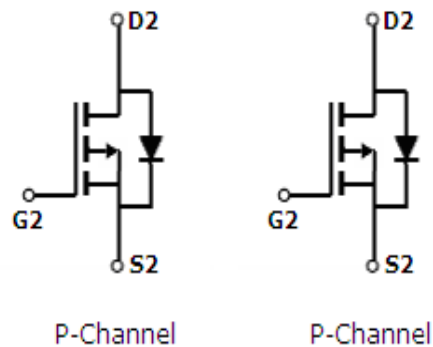
Y: Year Code  
A: Week Code  
Q: Prucess Code





**STP4953**  Lead-free

Dual P Channel Enhancement Mode MOSFET  
-5.2A

**ABSOLUTE MAXIMUM RATINGS** (Ta = 25°C Unless otherwise noted )

Parameter	Symbol	Typical	Unit
Drain-Source Voltage	V <sub>DSS</sub>	-30	V
Gate-Source Voltage	V <sub>GSS</sub>	±20	V
Continuous Drain Current (T <sub>J</sub> =150°C)	I <sub>D</sub>	T <sub>A</sub> =25°C -5.2	A
		T <sub>A</sub> =70°C -4.2	
Pulsed Drain Current	I <sub>DM</sub>	-30	A
Continuous Source Current (Diode Conduction)	I <sub>S</sub>	-2.3	A
Power Dissipation	P <sub>D</sub>	T <sub>A</sub> =25°C 2.7	W
		T <sub>A</sub> =70°C 1.8	
Operation Junction Temperature	T <sub>J</sub>	-55/150	°C
Storage Temperature Range	T <sub>STG</sub>	-55/150	°C
Thermal Resistance-Junction to Ambient	R <sub>θJA</sub>	70	°C/W

**ELECTRICAL CHARACTERISTICS** ( Ta = 25°C Unless otherwise noted )

Parameter	Symbol	Condition	Min	Typ	Max	Unit
<b>Static</b>						
Drain-Source Breakdown Voltage	$V_{(BR)DSS}$	$V_{GS}=0V, I_D=-250\mu A$	-30			V
Gate Threshold Voltage	$V_{GS(th)}$	$V_{DS}=V_{GS}, I_D=-250\mu A$	-1.0		-3.0	V
Gate Leakage Current	$I_{GSS}$	$V_{DS}=0V, V_{GS}=\pm 20V$			$\pm 100$	nA
Zero Gate Voltage Drain Current	$I_{DSS}$ $T_J=55^\circ C$	$V_{DS}=-30V, V_{GS}=0V$			-1	uA
		$V_{DS}=-30V, V_{GS}=0V$			-5	
On-State Drain Current	$I_{D(on)}$	$V_{DS}=-5V, V_{GS}=10V$	-25			A
Drain-source On-Resistance	$R_{DS(on)}$	$V_{GS}=-10V, I_D=-5.2A$		0.50	0.60	$\Omega$
		$V_{GS}=-6.0V, I_D=-4.5A$		0.60	0.80	
		$V_{GS}=-4.5V, I_D=-4.0A$		0.75	0.90	
Forward Tran Conductance	$g_{fs}$	$V_{DS}=-10V, I_D=-5.0A$		9.0		S
Diode Forward Voltage	$V_{SD}$	$I_S=-2.0A, V_{GS}=0V$		-0.8	-1.2	V
<b>Dynamic</b>						
Total Gate Charge	$Q_g$	$V_{DS}=-15V, V_{GS}=-10V$ $I_D=-5.0A$		15	10	nC
Gate-Source Charge	$Q_{gs}$			4.0		
Gate-Drain Charge	$Q_{gd}$			2.0		
Input Capacitance	$C_{iss}$	$V_{DS}=-15V, V_{GS}=0V$ $f=1MHz$		680		pF
Output Capacitance	$C_{oss}$			120		
Reverse Transfer Capacitance	$C_{rss}$			75		
Turn-On Time	$t_{d(on)}$ $t_r$	$V_{DD}=15V, R_L=15\Omega$ $I_D=-1.0A, V_{GEN}=-10V$ $R_G=6\Omega$		7.0	15	nS
				10	20	
Turn-Off Time	$t_{d(off)}$ $t_f$			40	80	
				20	40	

**TYPICAL CHARACTERISTICS (25°C Unless Note)**

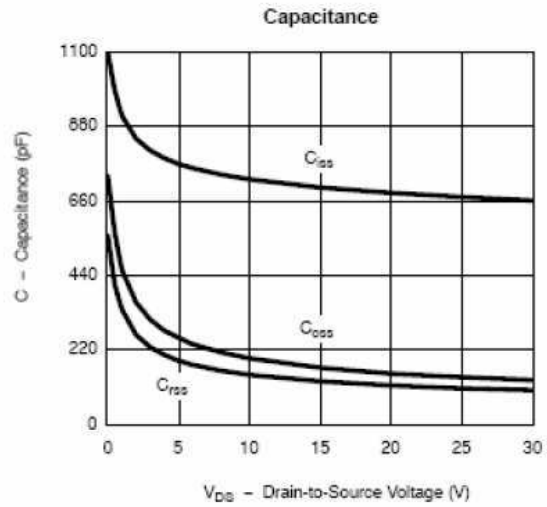
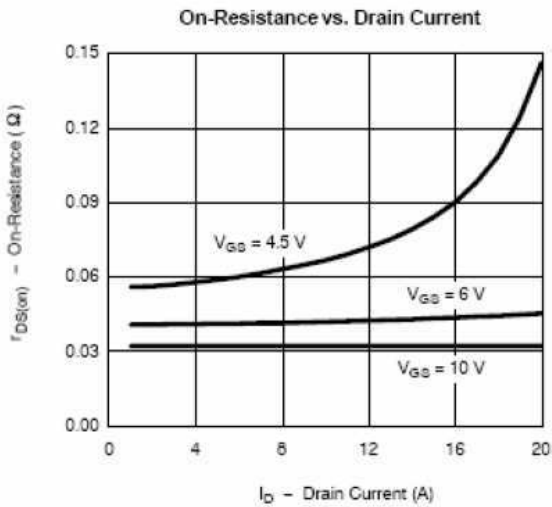
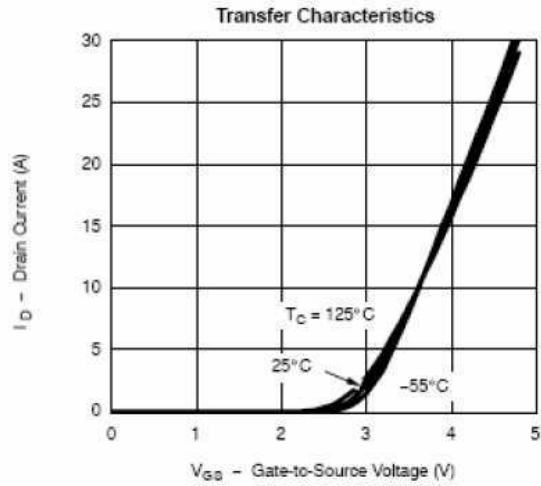
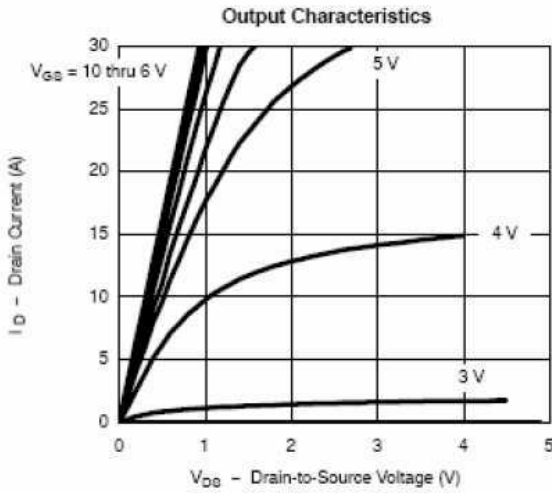

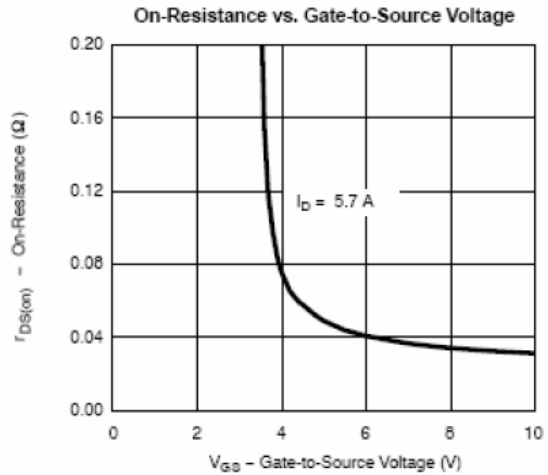
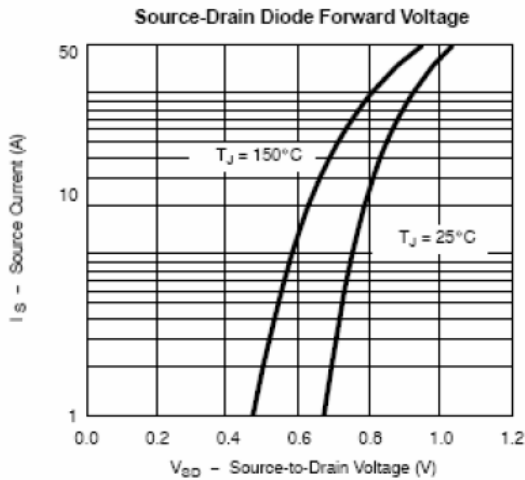
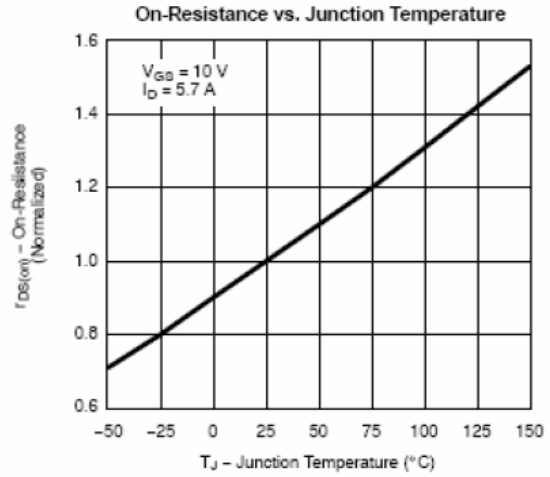
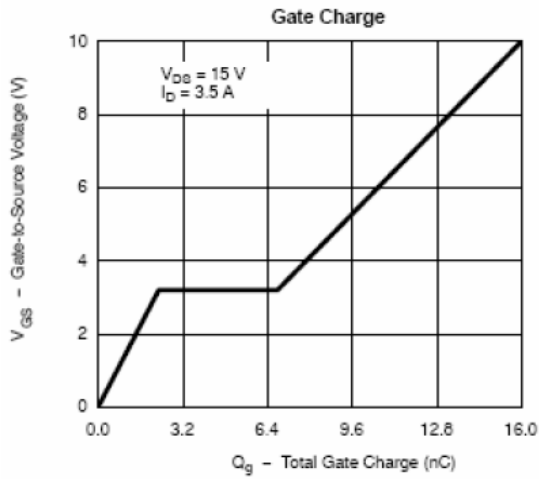

**TYPICAL CHARACTERISTICS (25°C Unless Note)**

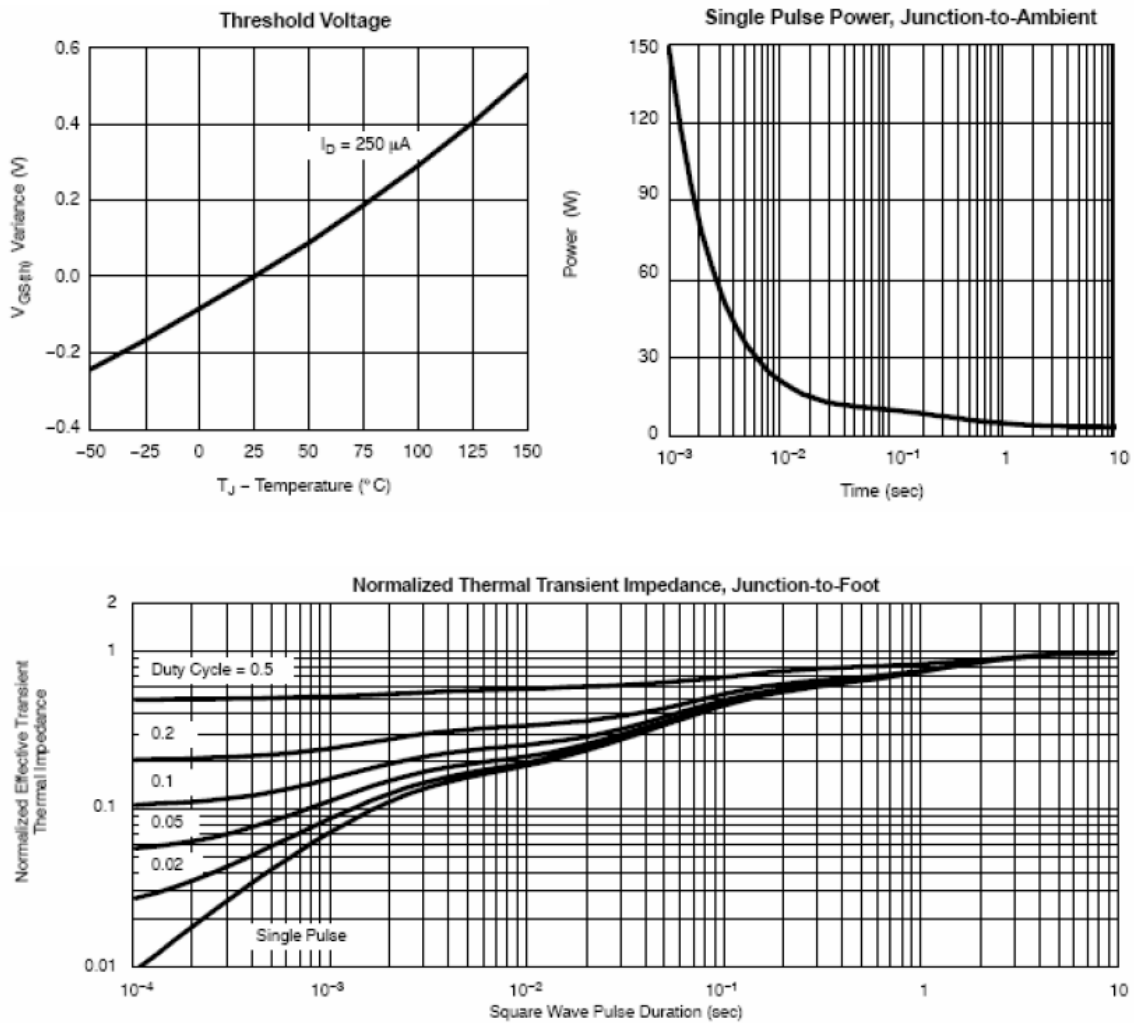

**TYPICAL CHARACTERISTICS** (25°C Unless Note)

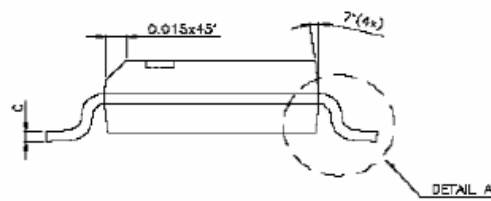
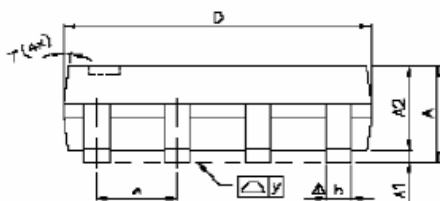
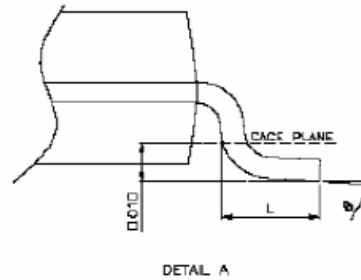
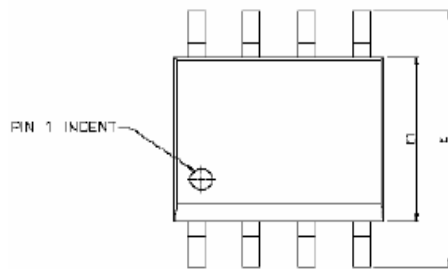

**SOP-8 PACKAGE OUTLINE**

SYMBOLS	DIMENSIONS IN MILLIMETERS			DIMENSIONS IN INCHES		
	MIN	NOM	MAX	MIN	NOM	MAX
A	1.47	1.60	1.73	0.058	0.063	0.068
A1	0.10	—	0.25	0.004	—	0.010
A2	—	1.45	—	—	0.057	—
b	0.33	0.41	0.51	0.013	0.016	0.020
C	0.19	0.20	0.25	0.0075	0.008	0.0098
D	4.80	4.85	4.95	0.189	0.191	0.195
E	5.80	6.00	6.20	0.228	0.236	0.244
E1	3.80	3.90	4.00	0.150	0.154	0.157
e	—	1.27	—	—	0.050	—
L	0.38	0.71	1.27	0.015	0.028	0.050
 y	—	—	0.076	—	—	0.003
⌀	0°	—	8°	0°	—	8°